

# TABLE OF CONTENTS

<b>1</b>	<b>Before driving</b>	Adjusting and operating features such as door locks, mirrors, and steering column.
<b>2</b>	<b>When driving</b>	Driving, stopping and safe-driving information.
<b>3</b>	<b>Interior features</b>	Air conditioning and audio systems, as well as other interior features for a comfortable driving experience.
<b>4</b>	<b>Maintenance and care</b>	Cleaning and protecting your vehicle, performing do-it-yourself maintenance, and maintenance information.
<b>5</b>	<b>When trouble arises</b>	What to do if the vehicle needs to be towed, gets a flat tire, or is involved in an accident.
<b>6</b>	<b>Vehicle specifications</b>	Detailed vehicle information.
<b>7</b>	<b>For US owners</b>	Reporting safety defects for US owners.
	<b>Index</b>	Alphabetical listing of information contained in this manual.

**1 Before driving**

1-1. **Key information** ..... 2  
 Keys ..... 2

1-2. **Opening, closing and locking the doors**..... 4  
 Wireless remote control ..... 4  
 Side doors ..... 6  
 Back door ..... 11

1-3. **Adjustable components** ..... 13  
 Front seats ..... 13  
 Rear seats ..... 15  
 Driving position memory system ..... 24  
 Head restraints ..... 26  
 Seat belts ..... 28  
 Steering wheel ..... 35  
 Inside rear view mirror ..... 36  
 Outside rear view mirrors ..... 37  
 Roof luggage carrier ..... 39

1-4. **Opening and closing the windows and moon roof** ..... 41  
 Power windows ..... 41  
 Moon roof ..... 43

1-5. **Refueling** ..... 46  
 Opening the fuel tank cap ..... 46

1-6. **Theft deterrent system**..... 49  
 Engine immobilizer system ..... 49  
 Alarm ..... 51  
 Theft prevention labels (U.S.A.) ..... 53

1-7. **Safety information**..... 54  
 Correct driving posture ..... 54  
 SRS airbags ..... 56  
 Front passenger occupant classification system ..... 69  
 Child restraint systems ..... 74  
 Installing child restraints ..... 77

**2 When driving**

2-1. **Driving procedures**..... 88  
 Driving the vehicle ..... 88  
 Starting the engine ..... 95  
 Automatic transmission ..... 98  
 Turn signal lever ..... 101  
 Parking brake ..... 102

2-2. **Instrument cluster** ..... 103  
 Gauges and meters ..... 103  
 Indicators and warning lights ..... 105  
 Trip information display ..... 108

<b>2-3. Operating the lights and windshield wipers</b> .....	111
Headlight switch.....	111
Fog light switch.....	113
Windshield wipers and washer.....	114
Rear window wiper and washer.....	117
<b>2-4. Using other driving systems</b> .....	118
Cruise control.....	118
Four-wheel drive system.....	121
Rear height control air suspension.....	123
Electronic modulated suspension.....	129
DAC (Downhill Assist Control system).....	130
Driving assist systems.....	132
<b>2-5. Driving information</b> .....	135
Off-road precautions.....	135
Cargo and luggage.....	140
Vehicle load limits.....	144
Winter driving tips.....	146
Trailer towing.....	150
Dinghy towing.....	160

### 3 Interior features

<b>3-1. Using the air conditioning system and defogger</b> .....	162
Automatic air conditioning system (without navigation system).....	162
Rear cooler system.....	168
Rear window and outside rear view mirror defoggers.....	169
<b>3-2. Using the audio system</b> .....	171
Audio system type.....	171
Using the radio.....	173
Using the CD player.....	181
Playing MP3 and WMA discs.....	188
Optimal use of the audio system.....	194
Using the AUX adapter.....	197
Using the steering switches.....	198
<b>3-3. Using the rear audio system</b> .....	200
Rear seat entertainment system features.....	200
Using the DVD player (DVD video).....	205
Using the DVD player (video CD).....	212
Using the DVD player (audio CD/CD text).....	214

Using the DVD player  
(MP3 discs)..... 215

Using the video mode ..... 217

Changing the initial setting ..... 218

**3-4. Using the interior lights ..... 225**

Interior lights list..... 225

**3-5. Using the storage**

**features..... 228**

List of storage features..... 228

**3-6. Other interior features..... 233**

Sun visors..... 233

Vanity mirror..... 234

Clock..... 235

Outside temperature  
display ..... 236

Ashtrays ..... 237

Cigarette lighter ..... 238

Power outlet..... 239

Seat heaters..... 241

Armrest ..... 243

Floor mats..... 244

Luggage compartment  
features..... 245

Garage door opener..... 248

Compass..... 253

Lexus Link System ..... 257

**4 Maintenance and care**

**4-1. Maintenance and care..... 272**

Cleaning and protecting the  
vehicle exterior ..... 272

Cleaning and protecting the  
vehicle interior..... 274

**4-2. Maintenance..... 277**

Maintenance requirements ..... 277

General maintenance..... 279

Emission inspection and  
maintenance (I/M)  
programs ..... 282

**4-3. Do-it-yourself  
maintenance..... 283**

Do-it-yourself service  
precautions..... 283

Hood..... 286

Engine compartment..... 287

Tires ..... 302

Tire inflation pressure..... 309

Wheels..... 313

Air conditioning filter..... 315

Wireless remote control  
battery..... 317

Rear seat entertainment  
system controller..... 319

Checking and replacing  
fuses..... 321

Light bulbs ..... 331



## 5 When trouble arises

- 5-1. **Essential information** ..... 338
  - If your vehicle needs to be towed..... 338
  - If you think something is wrong ..... 343
  - Fuel pump shut off system ..... 344
  - Event data recorder ..... 345
  
- 5-2. **Steps to take in an emergency** ..... 347
  - If a warning light turns on or a warning buzzer sounds... ..... 347
  - If you have a flat tire..... 356
  - If the engine will not start ..... 367
  - If the shift lever cannot be shifted from P ..... 368
  - If you lose your keys ..... 369
  - If the vehicle battery is discharged ..... 370
  - If your vehicle overheats ..... 373
  - If the vehicle becomes stuck..... 375

## 6 Vehicle specifications

- 6-1. **Specifications**..... 378
  - Maintenance data..... 378
  - Fuel information..... 387
  - Tire information ..... 390
  
- 6-2. **Customization** ..... 398
  - Customizable features ..... 398
  
- 6-3. **Initialization** ..... 401
  - Items to initialize ..... 401

## 7 For US owners

- Reporting safety defects for U.S. owners..... 404

## Index

- Alphabetical index..... 406
  
- What to do if..... 414



Fuel filler door P. 46

Door P. 6

Turn signal light P. 101

Rear window defogger P. 169

Back door P. 11



- Tire
- Rotation P. 302
  - Replacement P. 356
  - Inflation pressure P. 385
  - Information P. 390

Tail lights P. 111

Side marker light P. 111

# Pictorial index

# Interior

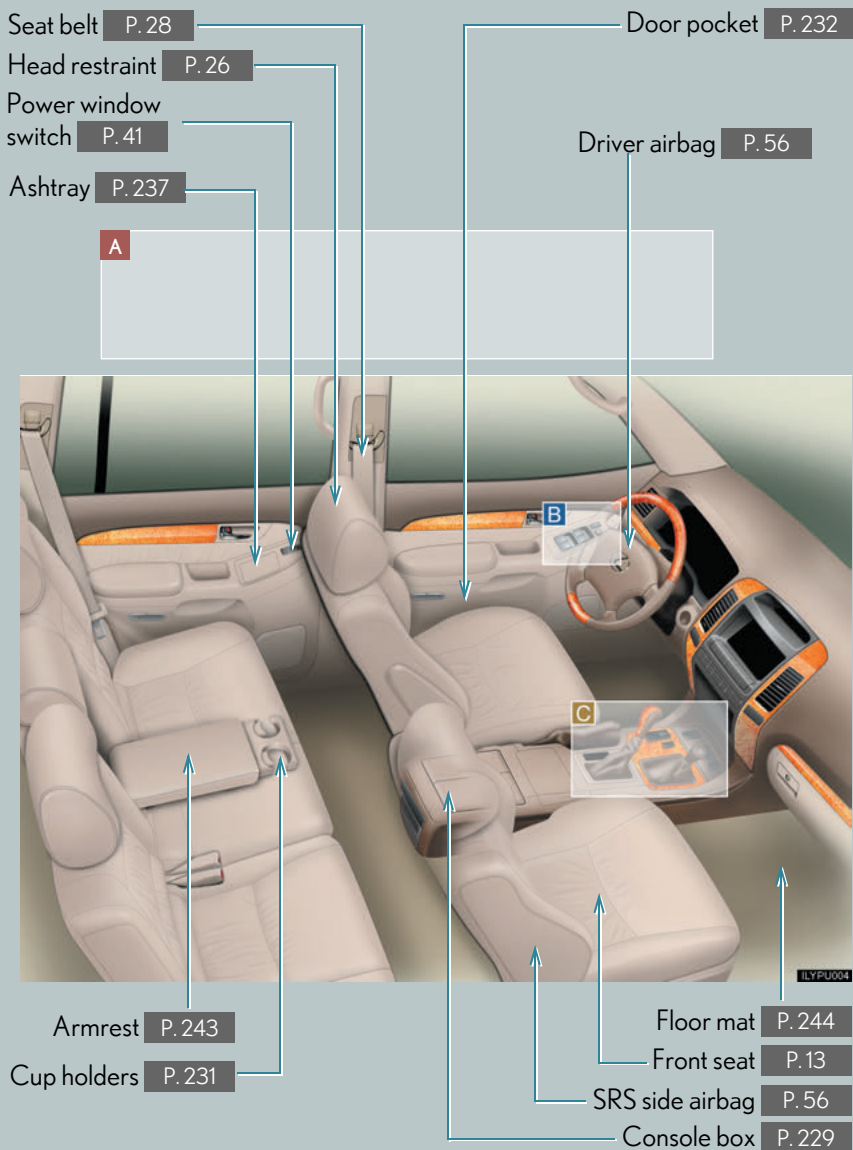

A

Lexus Link System switches\* P. 257

Moon roof switch P. 43

Garage door opener switches\* P. 248

Personal light P. 226

Interior light P. 227

Rear seat entertainment system\* P. 200

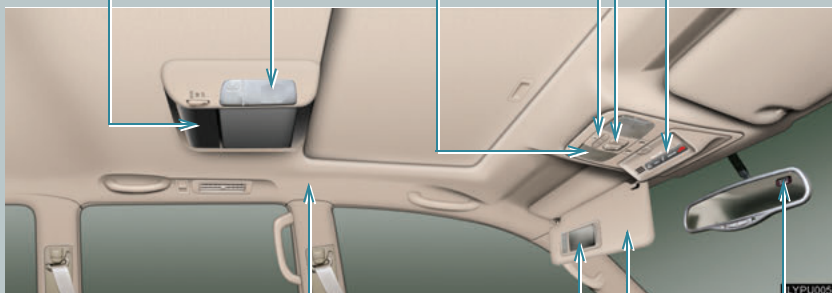

SRS curtain shield airbag P. 56

Vanity mirror P. 234

Sun visor P. 233

Compass\* P. 253

\*: If equipped

**B**

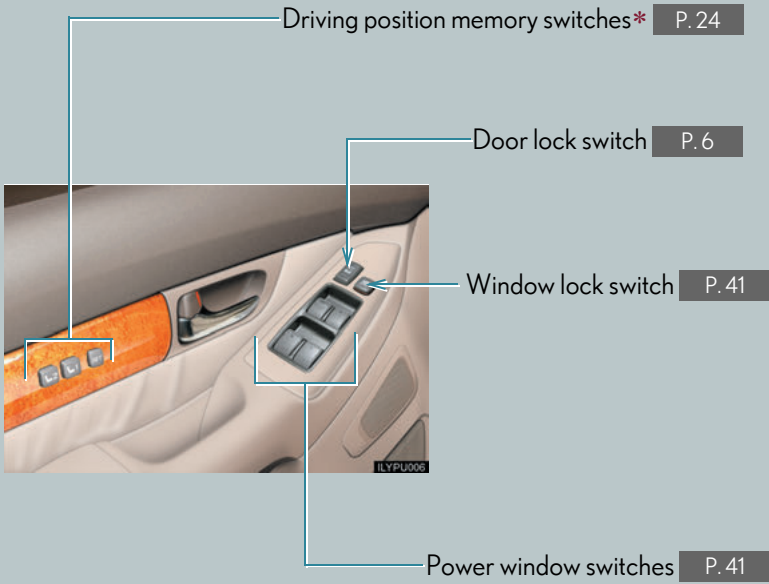

C

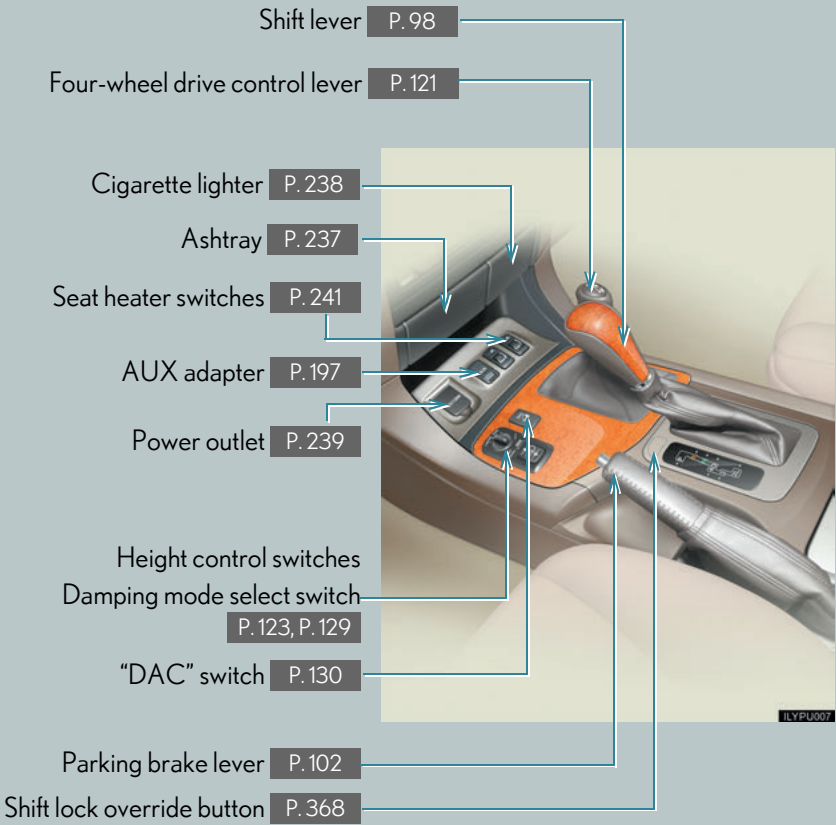

\*: If equipped

# Pictorial index

# Instrument panel

Gauges and meters P. 103

Headlight switch P. 111

Turn signal switch P. 101

Fog light switch P. 113

Ignition switch P. 95

Windshield wiper and washer switch P. 114

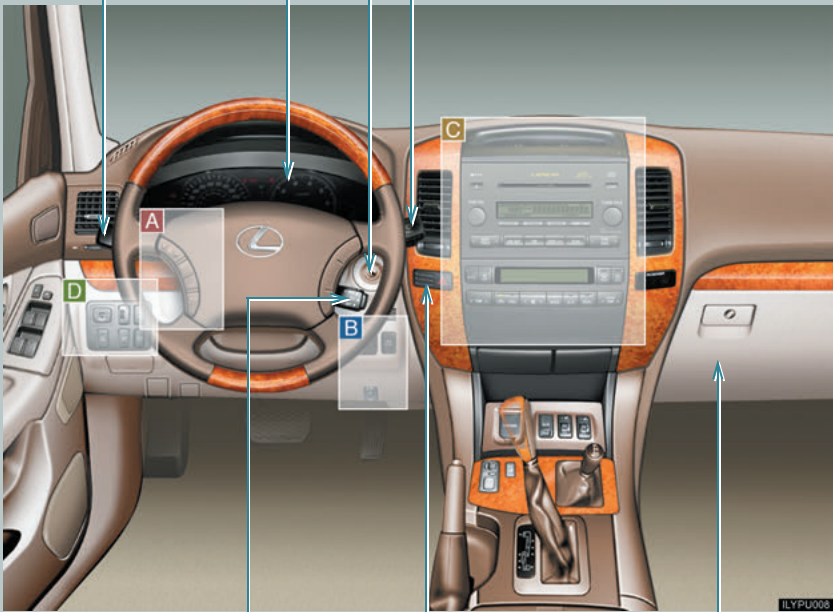

Cruise control switch P. 118

Glove box P. 228

Emergency flashers



A



Audio remote control switches P. 198

B

Automatic transmission second start switch P. 99

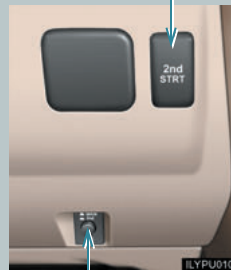

Tire selector switch P. 304

## C

► With navigation system

Trip-information display P. 108

Navigation system\*

Audio system P. 171

Air conditioning system



► Without navigation system

Trip-information display P. 108

Audio system P. 171

Air conditioning system P. 162



D

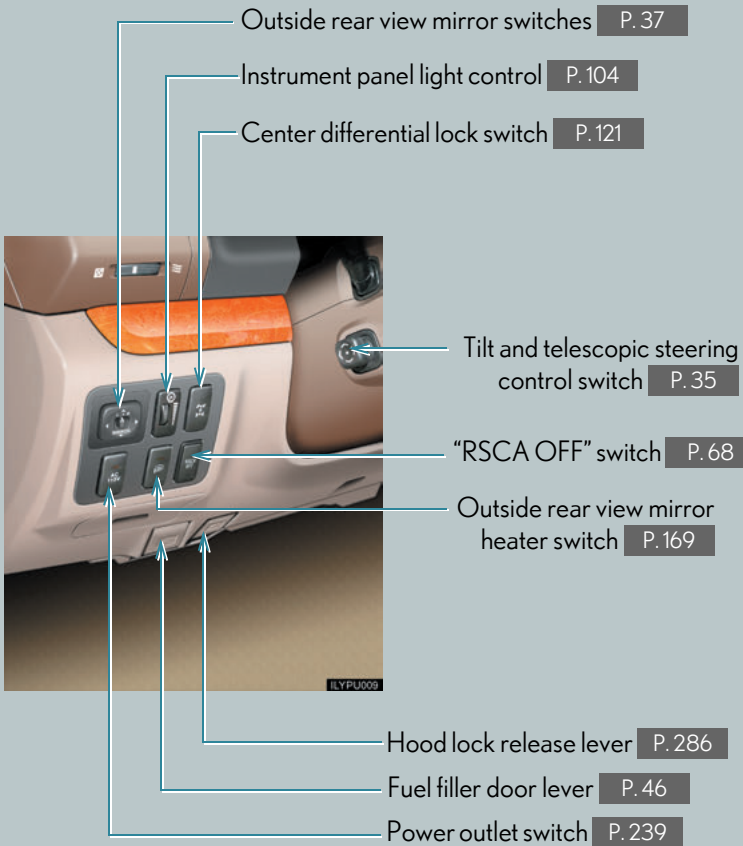

\*: Refer to "Navigation System Owner's Manual".

Child restraint anchor brackets P. 83

Power outlet P. 239

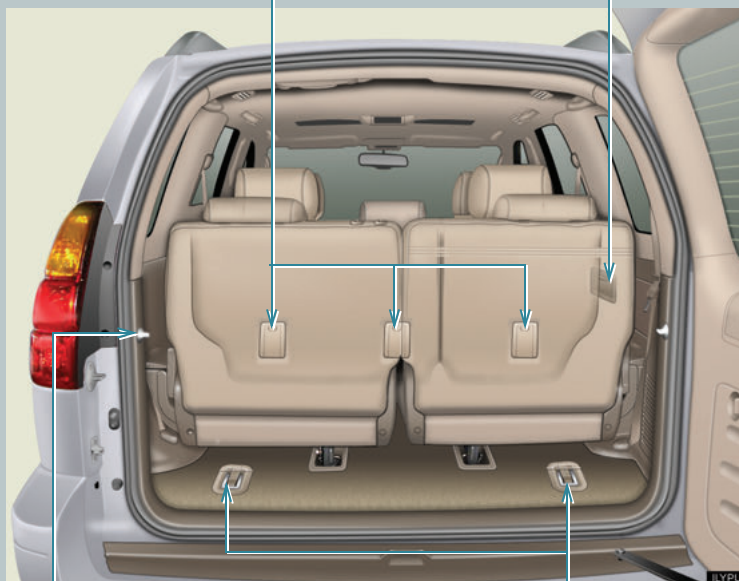

Cargo net hook P. 245

Cargo hooks P. 245

A

Back door handle

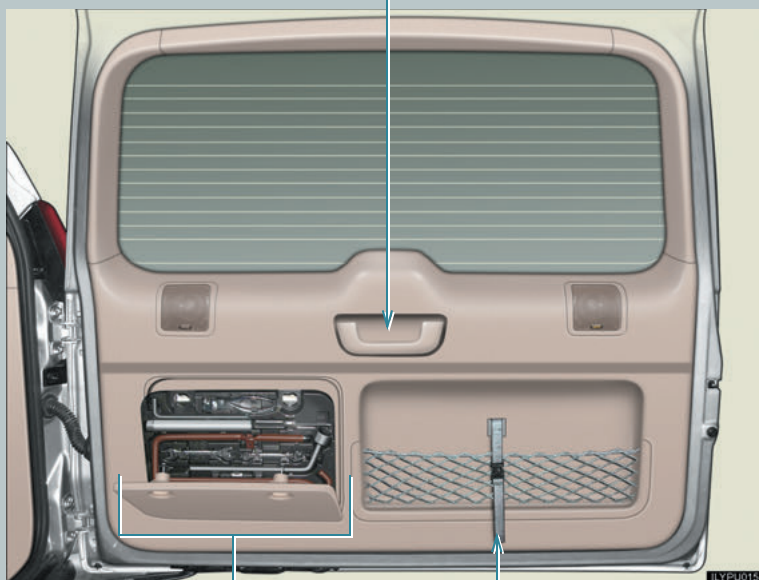

Tools P. 356

Warning reflector holder P. 246

## For your information

### Main Owner's Manual

Please note that this manual applies to all models and explains all equipment, including options. Therefore, you may find some explanations for equipment not installed on your vehicle.

All specifications provided in this manual are current at the time of printing. However, because of the Lexus policy of continual product improvement, we reserve the right to make changes at any time without notice.

Depending on specifications, the vehicle shown in the illustration may differ from your vehicle in terms of color and equipment.

### Accessories, spare parts and modification of your Lexus

A wide variety of non-genuine spare parts and accessories for Lexus vehicles are currently available in the market. You should know that Toyota does not warrant these products and is not responsible for their performance, repair, or replacement, or for any damage they may cause to, or adverse effect they may have on, your Lexus vehicle.

This vehicle should not be modified with non-genuine Lexus products. Modification with non-genuine Lexus products could affect its performance, safety or durability, and may even violate governmental regulations. In addition, damage or performance problems resulting from the modification may not be covered under warranty.

### Installation of a mobile two-way radio system

As the installation of a mobile two-way radio system in your vehicle could affect electronic systems such as the multiport fuel injection system/sequential multiport fuel injection system, cruise control system, anti-lock brake system, SRS airbag system and seat belt pretensioner system, be sure to check with your Lexus dealer for precautionary measures or special instructions regarding installation.

## Scrapping of your Lexus

The SRS airbag and seat belt pretensioner devices in your Lexus contain explosive chemicals. If the vehicle is scrapped with the airbags and seat belt pretensioners left as they are, this may cause an accident such as fire. Be sure to have the systems of the SRS airbag and seat belt pretensioner removed and disposed of by a qualified service shop or by your Lexus dealer before you scrap your vehicle.

## Leak detection pump (for the U.S.A. and Canada)

This pump performs fuel evaporation leakage check. This check is conducted several hours after the engine is turned off. You may hear a sound coming from underneath the luggage compartment for several minutes, however this does not indicate a malfunction.

### CAUTION

#### ■ General precautions while driving

**Driving under the influence:** Never drive your vehicle when under the influence of alcohol or drugs that have impaired your ability to operate your vehicle. Alcohol and certain drugs delay reaction time, impair judgment and reduce coordination, which could lead to an accident that will hurt or kill you, your occupants or others.

**Defensive driving:** Always drive defensively. Anticipate mistakes that other drivers or pedestrians might make and be ready to avoid accidents.

**Driver distraction:** Always give your full attention to driving. Anything that distracts the driver, such as adjusting controls, talking on a cellular phone or reading can result in a collision with resulting death or serious injury to you, your occupants or others.

#### ■ When children are in the vehicle

Never leave children unattended in the vehicle.

When left unattended, children may be able to start the vehicle or shift the vehicle into neutral. There is also a danger that children may injure themselves by playing with the cigarette lighter, the windows, the moon roof, or other features of the vehicle. In addition, heat build-up or extremely cold temperatures inside the vehicle can be fatal to children.

## Symbols used throughout this manual

### Cautions & Notices

#### CAUTION

This is a warning against anything which may cause injury to people if the warning is ignored. You are informed about what you must or must not do in order to reduce the risk of injury to yourself and others.

#### NOTICE

This is a warning against anything which may cause damage to the vehicle or its equipment if the warning is ignored. You are informed about what you must or must not do in order to avoid or reduce the risk of damage to your Lexus and its equipment.

### Safety symbol



Throughout this manual, you will also see the symbol of a circle with a slash through it. This means “Do not”, “Do not do this”, or “Do not let this happen”.



1-1. Key information.....	2	1-4. Opening and closing the windows and moon roof .....	41
Keys.....	2	Power windows .....	41
1-2. Opening, closing and locking the doors .....	4	Moon roof.....	43
Wireless remote control.....	4	1-5. Refueling.....	46
Side doors .....	6	Opening the fuel tank cap .....	46
Back door.....	11	1-6. Theft deterrent system.....	49
1-3. Adjustable components.....	13	Engine immobilizer system.....	49
Front seats .....	13	Alarm .....	51
Rear seats .....	15	Theft prevention labels (U.S.A.).....	53
Driving position memory system .....	24	1-7. Safety information.....	54
Head restraints.....	26	Correct driving posture .....	54
Seat belts .....	28	SRS airbags .....	56
Steering wheel.....	35	Front passenger occupant classification system.....	69
Inside rear view mirror .....	36	Child restraint systems .....	74
Outside rear view mirrors .....	37	Installing child restraints.....	77
Roof luggage carrier.....	39		

## 1-1. Key information

# Keys

The following keys are provided with the vehicle.



### ■ When required to leave a key to the vehicle with a parking attendant

Lock the glove box as circumstances demand. (→P. 228)

Carry the master key for your own use and leave the valet key only with the attendant.

### ■ Key number plate

Keep the plate in a safe place such as your wallet, not in the vehicle. In the event that a key is lost, a new key can be made at your Lexus dealer using the key number plate. (→P. 369)

 NOTICE**■ To prevent key damage**

- Do not bend the keys, expose them to high temperatures by placing them in direct sunlight, or get them wet.
- Do not expose the keys to electromagnetic materials or attach any material that blocks electromagnetic waves to the key surface.

## 1-2. Opening, closing and locking the doors

### Wireless remote control

The wireless remote control can be used to lock and unlock the vehicle.

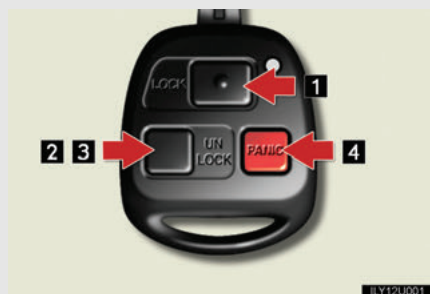

- 1 Locks all doors
- 2 Unlocks all doors
- 3 Opens the windows and moon roof (push and hold)
- 4 Sounds alarm (push and hold) (→P. 52)

#### ■ 2-step unlocking function

When you push the “UNLOCK” button, the driver's door is unlocked. Pushing the button again within 3 seconds unlocks the other doors.

#### ■ Operation indicator

- Doors: A buzzer sounds and the emergency flashers flash to indicate that the doors have been locked/unlocked. (Locked: Once; Unlocked: Twice)
- Windows and moon roof: A buzzer sounds when the windows and moon roof begin to open.

#### ■ Door lock buzzer

If a door is not fully closed, a buzzer sounds continuously if an attempt to lock the door is made. Fully close the door to stop the buzzer, and lock the vehicle once more.

#### ■ Security feature

If a door is not opened within approximately 30 seconds after the vehicle is unlocked, the theft deterrent system automatically locks the vehicle again.

#### ■ Low battery

If the wireless remote control does not function or if it only operates very close to the vehicle, the battery may be low. (→P. 317)

**■ Customization**

Settings (e.g. 2-step unlocking function, buzzer) can be changed. (→P. 398)

**■ Certification for wireless remote control (for vehicles sold in the U.S.A.)**

FCC ID: MOZRI-20BTY

**NOTE:**

This device complies with Part 15 of the FCC Rules. Operation is subject to the following two conditions: (1) This device may not cause harmful interference, and (2) this device must accept any interference received, including interference that may cause undesired operation.

**NOTICE:**

This equipment has been tested and found to comply with the limits for a Class B digital device, pursuant to Part 15 of the FCC Rules. These limits are designed to provide reasonable protection against harmful interference in a residential installation. This equipment generates, uses and can radiate radio frequency energy and, if not installed and used in accordance with the instructions, may cause harmful interference to radio communications. However, there is no guarantee that interference will not occur in a particular installation. If this equipment does cause harmful interference to radio or television reception, which can be determined by turning the equipment off and on, the user is encouraged to try to correct the interference by one or more of the following measures:

- Reorient or relocate the receiving antenna.
- Increase the separation between the equipment and receiver.
- Connect the equipment into an outlet on a circuit different from that to which the receiver is connected.
- Consult the dealer or an experienced radio/TV technician for help.

**FCC WARNING:**

Changes or modifications not expressly approved by the party responsible for compliance could void the user's authority to operate the equipment.

**■ Certification for wireless remote control (for vehicles sold in Canada)****NOTE:**

Operation is subject to the following two conditions: (1) this device may not cause interference, and (2) this device must accept any interference, including interference that may cause undesired operation of the device.

## 1-2. Opening, closing and locking the doors

### Side doors

The vehicle can be locked and unlocked using the wireless remote control, a key or door lock switch.

#### ■ Key

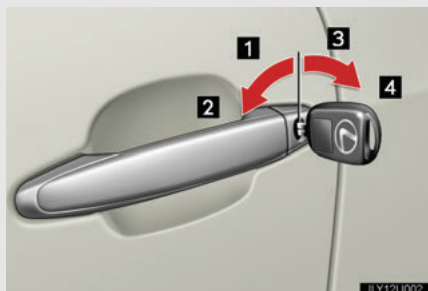

- 1 Locks all doors
- 2 Closes the windows/moon roof (turn and hold)
- 3 Unlocks all doors

Turning the key unlocks the driver's door. Turning the key once again unlocks the other doors.

- 4 Opens the windows/moon roof (turn and hold)

#### ■ Wireless remote control

→P. 4

#### ■ Door lock switch



- 1 Locks all doors
- 2 Unlocks all doors

### ■ Inside lock button

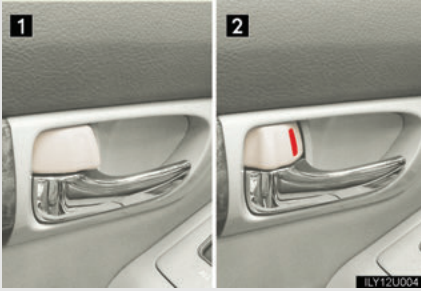

- 1** Locks the door
- 2** Unlocks the door

The front doors can be opened by pulling the inside handles even if the lock buttons are in the lock position.

### Rear door child-protector lock



The door cannot be opened from inside the vehicle when the locks are set.

These locks can be set to prevent children from opening the rear doors. Push down rear door switches to lock the rear doors.

### Automatic door locking and unlocking systems

The following functions can be set or canceled:

Function	Operation
Shift position linked door locking function	Shifting the shift lever out of "P" locks all doors.
Shift position linked door unlocking function	Shifting the shift lever to "P" unlocks all doors.
Speed linked door locking function	All doors are locked when the vehicle speed is approximately 12 mph (20 km/h) or higher.
Driver's door linked door unlocking function	All doors are unlocked when the driver's door is opened within 10 seconds after turning the ignition switch to the "ACC" or "LOCK" position.

#### ■ Setting and canceling the functions

To switch between setting and canceling, follow the procedure below:

**STEP 1** Close all the doors and turn the ignition switch to the "ON" position. (Perform step 2 within 10 seconds.)

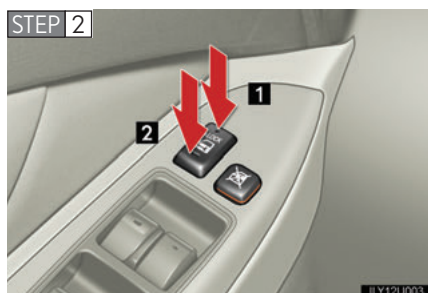

Shift the shift lever to "P" or "N", press and hold the driver's door lock switch (**1** or **2**) for 5 seconds then release.

The shift lever and switch positions corresponding to the desired function to be set or canceled are shown as follows.



Function	Shift lever position	Switch position
Shift position linked door locking function	"P"	1
Shift position linked door unlocking function		2
Speed linked door locking function	"N"	1
Driver's door linked door unlocking function		2

1

Before driving

When the setting or canceling operation is complete, all doors are locked and then unlocked.

#### ■ Locking the front doors from outside using the inside lock button

Push the inside lock button rearward and close the door while holding the door handle up.

#### ■ If the wrong key is used

The key cylinder rotates freely to isolate the inside mechanism.

#### ■ Customization

Settings (e.g. unlocking function using a key) can be changed. (→P. 398)

### CAUTION

#### ■ To prevent an accident

Observe the following precautions while driving the vehicle.

Failing to do so may result in a door opening and an occupant falling out, resulting in death or serious injury.

- Always use a seat belt.
- Always lock all doors.
- Ensure that all doors are properly closed.
- Do not pull the inside handle of the front door while driving.
- Set the rear door child protector locks when children are seated in the rear seat.

## 1-2. Opening, closing and locking the doors

### Back door

1

Before driving

The back door can be opened to the following positions:

#### ► Half open position

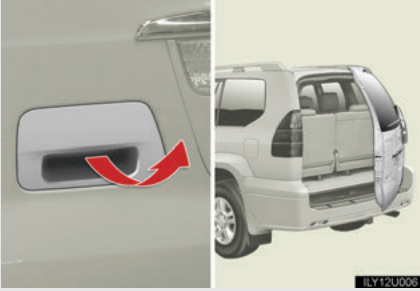

#### ► Full open position

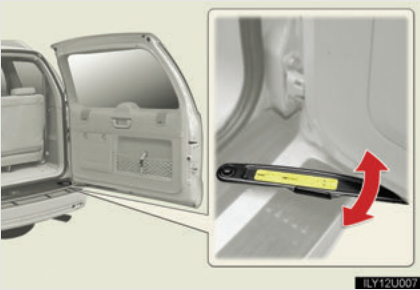

You can hold the back door in this position using the back door stopper.

When closing the door, be sure to unlock the back door stopper.

### Rear step bumper



For rear end protection and easier step-up loading.

### ■ The back door can be locked/unlocked

Using wireless remote control: →P. 4

Using door lock switch: →P. 6

### CAUTION

Observe the following precautions.

Failure to do so may result in death or serious personal injury.

#### ■ Caution while driving

- Keep the back door closed.

This not only keeps personal belongings from being thrown out, but also prevents exhaust gases from entering the vehicle.

- Do not get on the rear step bumper.

#### ■ If the back door is opened while parked

The open back door hides the rear lights. Other road users must be warned of the presence of your vehicle by a warning triangle or other device.

#### ■ When closing the back door

Make sure not to get your hands caught in the back door stay.

### NOTICE

#### ■ To prevent damage to the rear step bumper

Do not allow more than one person to get on at a time.

## 1-3. Adjustable components

### Front seats

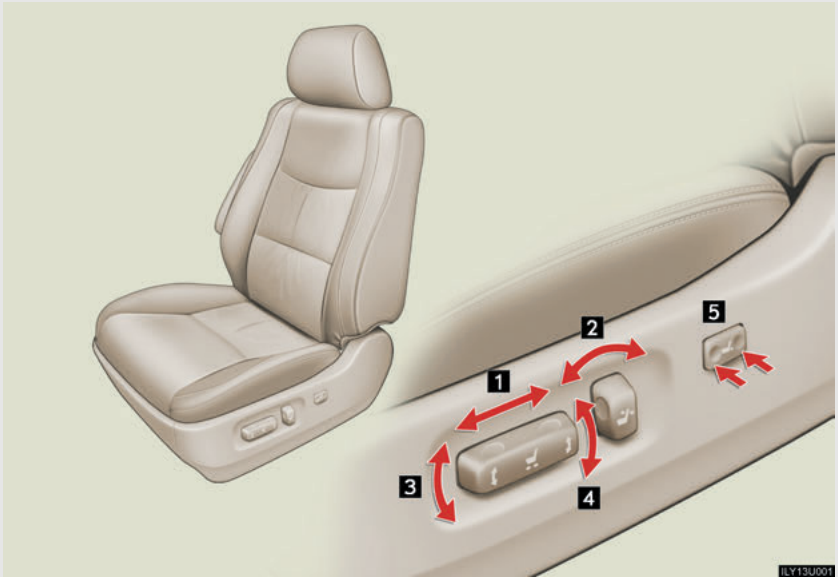

- 1** Seat position fore/aft control switch
  - 2** Seatback angle control switch
  - 3** Seat cushion (front) angle control switch\*
  - 4** Vertical height control switch\*
  - 5** Lumbar support control switch
- \*: For driver's seat only

1

Before driving

### CAUTION

#### ■ Reclining adjustment

Do not recline the seat more than necessary when the vehicle is in motion, to reduce the risk of sliding under the lap belt.

If the seat is too reclined during an accident, the lap belt may slide past the hips and apply restraint forces directly to the abdomen or your neck may contact the shoulder belt, increasing the risk of death or serious injury.

#### ■ When adjusting the front passenger's seat from the driver's seat

Wait until a passenger is seated or have gotten off the front passenger's seat before operating the switch to avoid injuring the passenger.

## 1-3. Adjustable components

### Rear seats

To adjust the seat back angle, pull the lock release lever.

► Second seats



► Third seats (if equipped)



## Tumbling the second seat (for third seat entry)

Vehicles with third seat: For easy access to the third seat, tumble the second seat in accordance with the following procedure.

### ■ Before tumbling the second seat



Stow the rear seat belt buckles.

### ■ Tumbling the second seat

**STEP 1** Lower the head restraints to the lowest position.

**STEP 2**



Fold down the seatbacks while pulling the lock release levers.

**STEP 3**

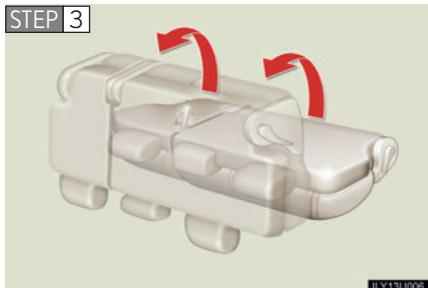

Swing the seat up and forward until it locks in place.



### ■ Returning the second seat



Push the red knobs and swing the seat down, then raise the seat-backs.

### ■ If you cannot raise the left side seatback

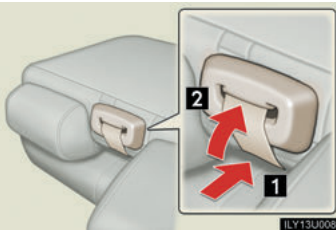

Release the seat belt lock by:

- 1 Pushing on the lower front edge of the seatback to slacken the seat belt.
- 2 Let the seat belt retract a little.

## Folding up the third seats

### ■ Before folding up the third seats

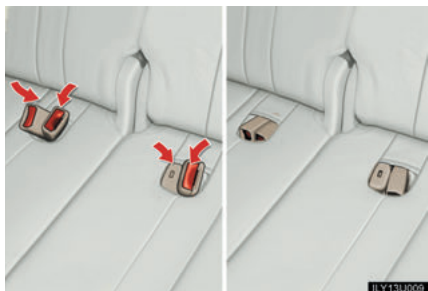

Stow the rear seat belt buckles.

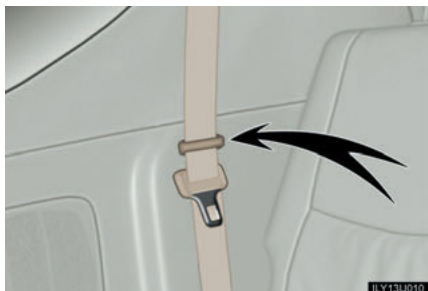

Use the seat belt hangers to prevent the belts from becoming tangled.

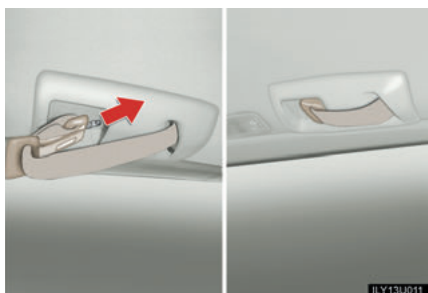

For the center seat belt, stow the seat belt tabs in the cover set in the roof as shown.

## ■ Folding up the third seats

**STEP 1** Lower the outboard head restraint to the lowest position and remove the center head restraint.

**STEP 2** Stow the center head restraint in the seatback. (→P. 27)

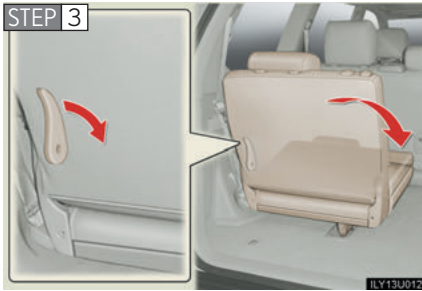

Unlock the seatbacks by pushing the lock release levers forward, and fold them down.

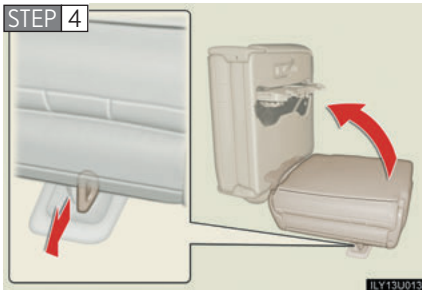

Unlock the seat legs by pulling the seat leg lock release handles, and lift the seats sideward.

## 1-3. Adjustable components



Retract the seat legs, then take the holding straps out and attach the straps to the assist grips.

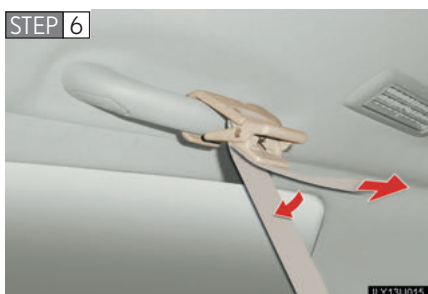

Pull the free end of the straps to secure the seats.

### ■ When returning the third seat to its original position

Reverse the steps listed.



Be sure to stow the holding straps as shown.

## Removing the third seats

**STEP 1** Follow the procedure for “Folding up the third seats” up to STEP 3.

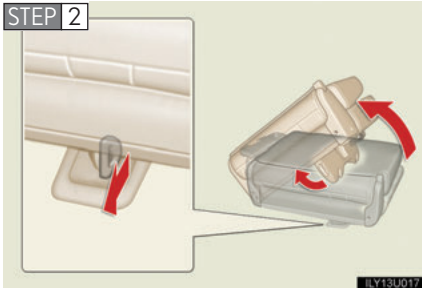

Unlock the seat legs by pulling the seat leg lock release handles, and lift the seats. Retract the seat legs, then place the seats on the floor.

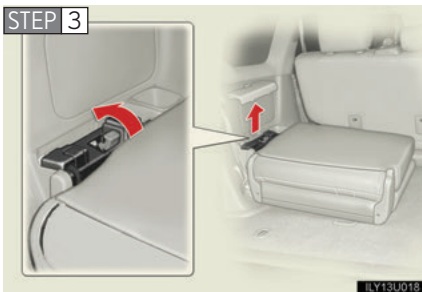

Remove the seat lock cover and push the red seat lock release knobs outward, then lift the seats free.

### ■ When returning the third seat to its original position

Reverse the steps listed.

### CAUTION

#### ■ Reclining adjustment

Do not recline the seat more than necessary when the vehicle is in motion, to reduce the risk of sliding under the lap belt.

If the seat is too reclined during an accident, the lap belt may slide past the hips and apply restraint forces directly to the abdomen or your neck may contact the shoulder belt, increasing the risk of death or serious injury.

#### ■ When the seatback is folded

Do not sit on or place anything on the seatback while driving.

#### ■ When returning the seatbacks to their original position

Observe the following precautions. Failure to do so may result in death or serious injury.

- Be careful not to get your hands or feet pinched in the seat.
- Make sure the seats are securely locked. Failure to do so will prevent the seat belt from operating properly.
- Check that the seat belts are not twisted or caught under the seat.
- Arrange the seat belts in the proper positions for ready use.

#### ■ When folding up the third seats

Fix the seats securely by adjusting the length of the holding strap. Failure to do so may cause death or serious injury in the event of an accident or sudden braking.

#### ■ When removing or reinstalling the third seats

Observe the following precautions to prevent personal injury:

- Do not remove or reinstall the seats while the vehicle is moving.
- Do not leave the removed seat loose in the vehicle.
- Be careful not to get your hands or feet pinched in the seats.
- Be careful not to hit a person with the removed seat or drop it on yourself.
- Do not sit on or place anything on the removed seat.
- Install each seat in the same position from which it was removed. Failure to do so will prevent third seat occupants from using the seat belts properly.

 NOTICE**■ Before tumbling, folding up or removing the seats**

The seat belts and buckles must be stowed.

**■ Before tumbling the second seats**

The headphone jack lid of the rear seat entertainment system must be closed.

**■ Removed third seats**

Avoid putting heavy loads on the seats. The metallic tips of the seat legs may be damaged, and you may be unable to correctly reinstall the seats.

## 1-3. Adjustable components

# Driving position memory system

Your preferred driving position (the position of the driver's seat, steering wheel and outside rear view mirrors) can be entered into the computer's memory and recalled with the touch of a button.

Two different driving positions can be entered into memory.

### ■ Entering a position into memory

Check that the shift lever is set in "P".

**STEP 1** Turn the ignition switch to the "ON" position.

**STEP 2** Adjust the driver's seat, steering wheel, and outside rear view mirrors to the desired positions.



While pushing the "SET" button, push button "1" or "2" until the signal beeps.

If the selected button has already been preset, the previously recorded position will be overwritten.

### ■ Recalling the memorized position

Check that the shift lever is set in "P".

**STEP 1** Turn the ignition switch to the "ON" position.



Push button "1" or "2" to recall the desired position.



**■ Retained accessory power**

Each memorized position (except for the tilt and telescopic steering column) can be activated within 30 seconds after the driver's door is opened, even if the key is not in the ignition switch.

**■ If any position memory button is pushed while the adjustments are being made**

The operation will stop. To reactivate the system, push the button again.

**■ If the battery is disconnected**

The memorized positions must be reset because the computer's memory is erased when the battery is disconnected.

**⚠ CAUTION****■ Seat adjustment caution**

Take care during seat adjustment that the seat does not strike the rear passenger or squeeze your body against the steering wheel.

If this happens, you can stop the movement by pressing another seat position memory button.

## 1-3. Adjustable components

# Head restraints

### Vertical adjustment

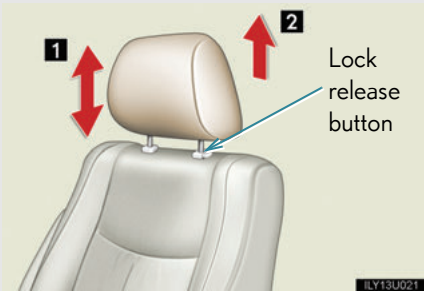

**1** Grip the head restraint and move it up or down.

Push and hold the lock release button when lowering the head restraint.

**2** Grip the head restraint and remove while holding the lock release button.

### Horizontal adjustment



Grip the head restraint and twist to tilt forward or backward.

### Adjusting the height of the head restraints

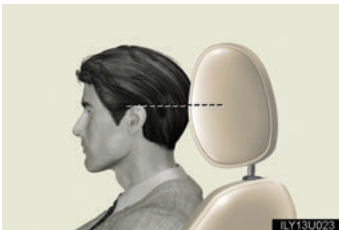

Make sure that the head restraints are adjusted so that the center of the head restraint is closest to the top of your ears.

### ■ When an occupant sits on the second center seat

Always pull up the head restraint to the lock position.

### ■ Head restraints of different seats

The head restraints are specially designed for the seats on which they are installed.

### ■ When not using the third center seat head restraint (vehicles with third seat)

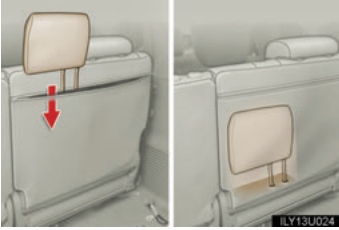

Open the zipper on the back of the third seat and stow the head restraint inside.

1

Before driving

## ⚠ CAUTION

### ■ Head restraint precautions

Observe the following precautions regarding the head restraints. Failure to do so may result in death or serious injury.

- Adjust the head restraints to the correct position at all times.
- Do not drive with the head restraints removed.

## 1-3. Adjustable components

# Seat belts

Make sure that all occupants are wearing their seat belts before driving the vehicle.

### ■ Correct use of the seat belts



- 1 Extend the shoulder belt so that it comes fully over the shoulder, but does not come into contact with the neck or slide off the shoulder.
- 2 Position the lap belt as low as possible over the hips.
- 3 Adjust the position of the seatback. Sit up straight and well back in the seat.
- 4 Do not twist the seat belt.

### ■ Fastening and releasing the seat belt

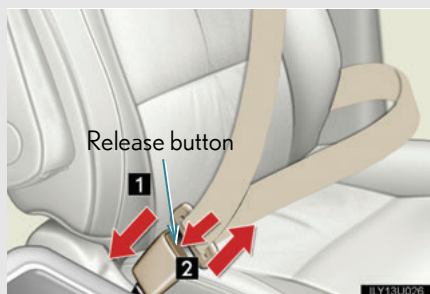

- 1 Fastening the belt  
Push the tab into the buckle until a clicking sound is heard.
- 2 Releasing the belt  
Press the release button.

### ■ Adjusting the height of the belt (front and second outboard seats)

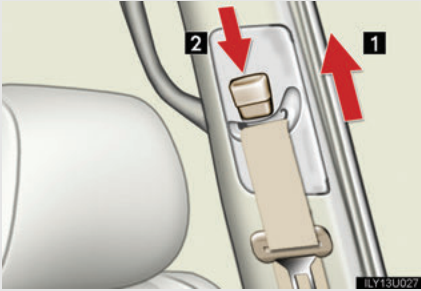

- 1 Up
- 2 Down

Move the height adjuster up and down as needed until you hear a click.

1

Before driving

### Third center seat belt (vehicles with third seats)

The third center seat belt is a 3-point type restraint with 2 buckles. Both seat belt buckles must be correctly located and securely latched for proper operation.



Make sure that the buckle with the light gray buckle release button is securely latched for ready use of the center seat belt.

### ■ Release method

The belt can be completely released when not required, such as when removing the third seat.

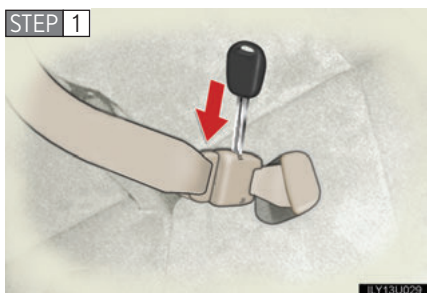

To release the hooked tab, insert the vehicle's key into the hole on the buckle with the light gray buckle release button.

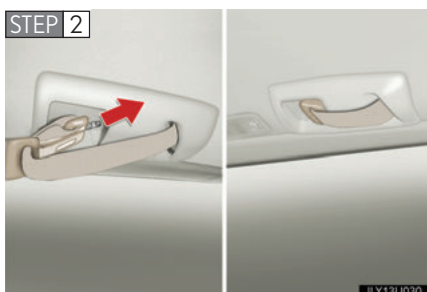

Stow the seat belt tabs in the cover set in the roof as shown.

### ■ Extracting the belt

Pull the belt out partially, then remove the tabs from the cover.

## Seat belt pretensioners (front seats)

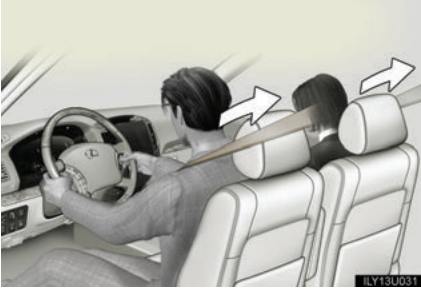

The pretensioner helps the seat belt to quickly restrain the occupant by retracting the seat belt when the vehicle is subjected to certain types of severe frontal collision.

The pretensioner may not activate in the event of a minor frontal impact, a side impact or a rear impact.

1

Before driving

### ■ Emergency locking retractor (ELR)

The retractor will lock the belt during a sudden stop or on impact. It may also lock if you lean forward too quickly. A slow, easy motion will allow the belt to extend, and you can move around fully.

### ■ Automatic locking retractor (ALR)

When a passenger's shoulder belt is completely extended and then retracted even slightly, the belt is locked in that position and cannot be extended. This feature is used to hold the child restraint system (CRS) firmly. To free the belt again, fully retract the belt and then pull the belt out once more. (→P. 81)

### ■ Pregnant women

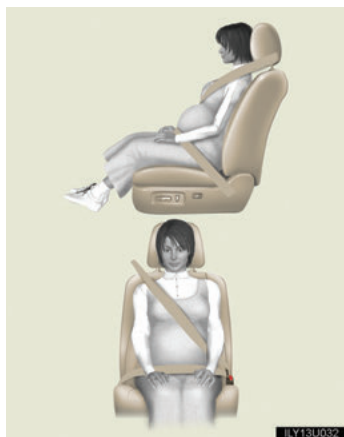

Obtain medical advice and wear the seat belt in the proper way. (→P. 28)

Women who are pregnant should position the lap belt as low as possible over the hips in the same manner as other occupants. Extend the shoulder belt completely over the shoulder and position the belt across the chest. Avoid belt contact over the rounding of the abdominal area.

If the seat belt is not worn properly, not only a pregnant woman, but also the fetus could suffer death or serious injury as a result of sudden braking or a collision.

### ■ People suffering illness

Obtain medical advice and wear the seat belt in the proper way. (→P. 28)

### ■ Child seat belt usage

The seat belts of your vehicle were principally designed for persons of adult size.

- Use a child restraint system appropriately for the child, until the child becomes large enough to properly wear the vehicle's seat belt. (→P. 74)
- When the child becomes large enough to properly wear the vehicle's seat belt, follow the instructions on P. 28 regarding seat belt usage.

### ■ Replacing the belt after the pretensioner has been activated

The seat belts cannot be used if a pretensioner has activated. After an accident, have your Lexus dealer inspect the pretensioners and replace them, if necessary.

### ■ Seat belt extender



If your seat belts cannot be fastened securely because they are not long enough, a personalized seat belt extender is available from your Lexus dealer free of charge.



 **CAUTION****■ Wearing a seat belt**

Observe the following precautions to reduce the risk of injury in the event of sudden braking or an accident. Failing to do so may cause death or serious injury.

- Ensure that all passengers wear a seat belt.
- Always wear a seat belt properly.
- Each seat belt should be used by one person only. Do not use a seat belt for more than one person at the same time, including children.
- Children should be seated in the rear seat and always use a seat belt and/or an appropriate child restraint system.
- Do not recline the seat any more than necessary to achieve a proper seating position. The seat belt is most effective when the occupants are sitting up straight and well back in the seats.
- Do not wear the shoulder belt under your arm.
- Always wear your seat belt low and snug across your hips.

**■ Seat belt damage and wear**

- Do not damage the seat belts by allowing the belt, plate or buckle to be jammed in the door.
- Inspect the seat belt system periodically. Check for cuts, fraying, and loose parts. Do not use a damaged seat belt until it is replaced. Damaged seat belts cannot protect an occupant from injury.
- Ensure that the belt and tab are locked and the belt is not twisted. If the seat belt does not function correctly, immediately contact your Lexus dealer.
- Replace the seat assembly, including the belts, if your vehicle has been involved in a serious accident, even if there is no obvious damage.
- Do not attempt to install, remove, modify, disassemble or dispose of a seat belt. Have any necessary repairs carried out by your Lexus dealer. Inappropriate handling of the pretensioner may cause it to activate or operate improperly and may cause death or serious injury.

### CAUTION

#### ■ When using the third center seat belt



Do not use the third center seat belt with either buckle released. Fastening only one of the buckles may result in death or serious injury in case of sudden braking or a collision.

#### ■ Using a seat belt extender

- Do not wear the seat belt extender, if you can fasten the seat belt without the extender.
- Do not use the seat belt extender when installing a child restraint system, because the belt will not securely hold the child restraint system, increasing the risk of death or serious injury in the event of a collision.
- The personalized extender may not be safe on another vehicle, when used by another person, or at a different seating position other than the one originally intended.

### NOTICE

#### ■ When using a seat belt extender

When releasing the seat belt, press on the buckle release button on the extender, not on the seat belt.

This helps prevent damage to the vehicle interior and the extender itself.

## 1-3. Adjustable components

# Steering wheel

The steering wheel can be adjusted to a comfortable position while the ignition switch is in the “ACC” or “ON” position.

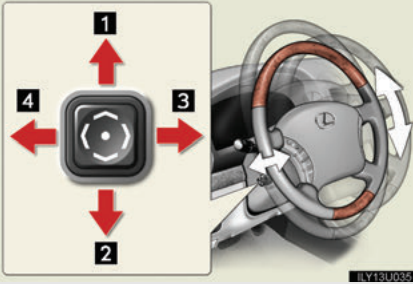

- 1 Up
- 2 Down
- 3 Toward the driver
- 4 Away from the driver

### Auto tilt away and auto return

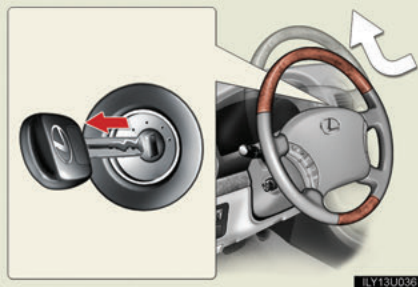

When the ignition key is removed, the steering wheel returns to its stowed position by moving up and away to enable easier driver entry and exit.

When the key is inserted in the ignition switch, the steering wheel will return to the original position.

### ⚠ CAUTION

#### ■ Caution while driving

Do not adjust the steering wheel.

Doing so may cause the driver to mishandle the vehicle and may lead to an accident, resulting in death or serious injury.

## 1-3. Adjustable components

### Inside rear view mirror

In the auto mode, sensors are used to detect the headlights of vehicles behind and automatically reduces the reflected light.



Press the switch to turn auto mode on/off.

The indicator comes on when auto mode is turned ON.

The anti-glare mirror is automatically set to auto mode whenever the ignition switch is turned to the "ON" position.

#### ■ To prevent sensor error

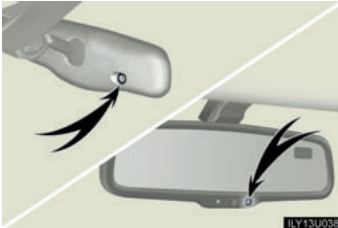

To ensure correct functioning of the sensors, do not touch or cover the sensors.

#### ⚠ CAUTION

##### ■ Caution while driving

Do not adjust the position of the mirror.

Doing so may lead to mishandling of the vehicle and may cause an accident, resulting in death or serious injury.

## 1-3. Adjustable components

# Outside rear view mirrors

Mirror angle can be adjusted using the switch when the ignition switch is in the "ACC" or "ON" position.



- 1 Select the mirror to adjust ("L": left or "R": right)
- 2 Adjust the mirror up, down, in, or out using the switch

1

Before driving

## Folding the mirrors

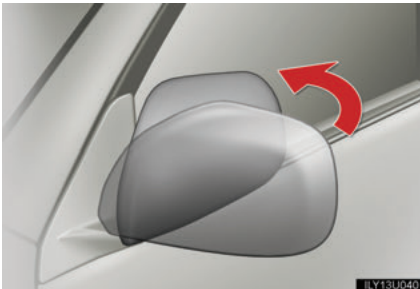

Push backward

### ■ When the mirrors are fogged up

Turn on the mirror heaters to defog the mirrors. (→P. 169)

### ■ Linked mirror function when reversing

The outside rear view mirrors will automatically angle downwards when the vehicle is reversing in order to give a better view of the ground. However, this function will not operate when the mirror select switch is in the neutral position (neither "L" nor "R" selected).

### ■ One-touch adjustment of the mirror angle (vehicles with driving position memory)

A desired mirror face angle can be entered to memory and adjusted with the touch of a button. (→P. 24)

#### CAUTION

##### ■ Caution while driving

Observe the following precautions.

Failing to do so may result in losing control of the vehicle and cause an accident, resulting in death or serious injury.

- Do not adjust the mirrors.
- Do not drive with the mirrors folded back.
- Before driving, be sure to extend the mirrors and adjust properly.

##### ■ When the mirror heaters are operating

Do not touch the mirror surface as the mirror surface becomes hot.

And do not touch the mirror surface also when the wiper switch is on at lower than 77°F (25°C) of the outside temperature.

#### NOTICE

##### ■ If ice should jam the mirror

Do not operate the control or scrape the mirror face. Use a spray de-icer to free the mirror.

## 1-3. Adjustable components

# Roof luggage carrier (if equipped)

1

Before driving

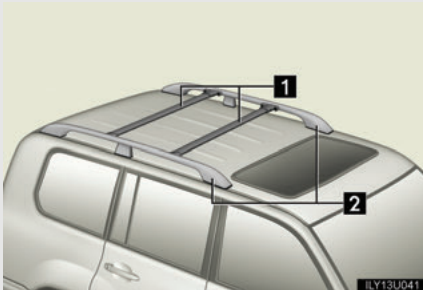

## Adjusting the position of cross rails

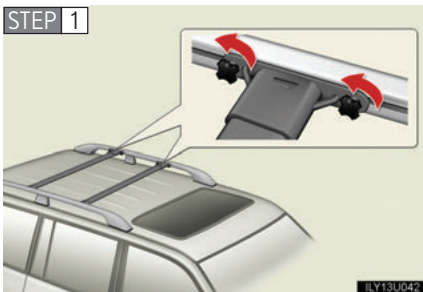

Turn the knobs counterclockwise to loosen the cross rails.

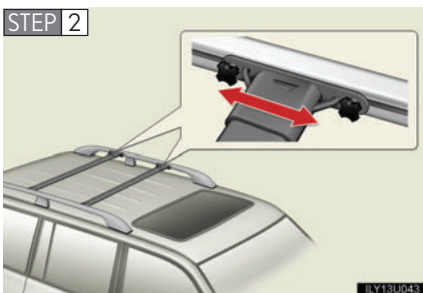

Slide the cross rails to the appropriate position for loading luggage.

After adjusting, be sure to tighten the cross rails by turning knobs clockwise.

### CAUTION

#### ■ Cross rail adjustment

Make sure the cross rails are locked securely by applying pressure forward and rearward.

Failure to do so may cause an accident, death or serious injury in the event of emergency braking or a collision.

#### ■ When loading cargo

Observe the following precautions:

- Place the cargo so that its weight is distributed evenly between the front and rear axles.
- If loading long or wide cargo, never exceed the vehicle overall length or width. (→P. 378)
- Before driving, make sure the cargo is securely fastened to the roof luggage carrier.
- Loading cargo on the roof luggage carrier will raise the vehicle's center of gravity. Avoid high speeds, sudden starts, sharp turns, sudden braking or abrupt maneuvers, otherwise unexpected loss of control or vehicle rollover may occur.
- If driving for a long distance, on rough roads, or at high speeds, stop the vehicle occasionally during the trip to make sure the cargo remains securely fastened.
- Do not exceed 130 lb. (58 kg) cargo weight on the roof luggage carrier.

### NOTICE

#### ■ When loading the luggage

Be careful not to scratch the surface of the moon roof.

#### ■ Cross rail stoppers

To prevent damage the moon roof, do not remove the cross rail stoppers.



## 1-4. Opening and closing the windows and moon roof

### Power windows

The power windows can be opened and closed using the following switches.

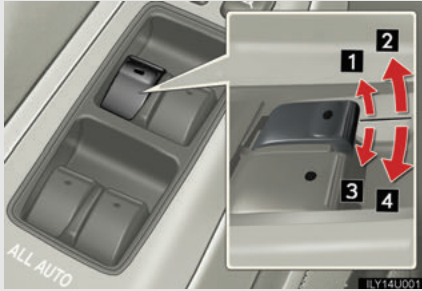

- 1 Closing
- 2 One-touch closing\*
- 3 Opening
- 4 One-touch opening\*

\*: Pushing the switch in the opposite direction will stop window travel partway.

1

Before driving

### Lock switch



Press the switch down to lock the passenger window switches.

Use this switch to prevent children from accidentally opening or closing a passenger window.

#### ■ The power windows can be operated when

The ignition switch is in the "ON" position.

#### ■ Linked door lock window operation

- The power windows can be opened and closed using the key. (→P. 6)
- The power windows can be opened using the wireless remote control. (→P. 4)

### ■ Retained accessory power operation

The power windows can be operated for approximately 45 seconds even after the ignition switch is turned to the "ACC" or "LOCK" position. They cannot, however, be operated once the driver's or front passenger's door is opened.

### ■ Jam protection function

If an object becomes caught between the window and the window frame, window travel is stopped and the window is opened slightly.

### ■ When the battery is disconnected

The power windows must be initialized in order to ensure proper operation. (Perform for each window with the switch for each seat.)

**STEP 1** Open the window halfway.

**STEP 2** Fully close the window by pulling the switch up and continue holding the switch for 1 second.

The indicator on the switch changes from a flashing pattern to being on when initialization are complete.

### ■ Customization

Settings (e.g. linked door lock operation) can be changed. (→P. 399)

## CAUTION

### ■ When closing the windows

Observe the following precautions.

Failing to do so may result in death or serious injury.

- Check to make sure that all passengers do not have any part of their body in a position where it could be caught when a window is being operated.
- Do not allow children to operate the power windows.  
Closing a power window on someone can cause death or serious injury.

### ■ Jam protection function

- Never try jamming any part of your body to activate the jam protection function intentionally.
- The jam protection function may not work if something gets caught just before the window fully closes.

## 1-4. Opening and closing the windows and moon roof

### Moon roof

Use the overhead switches to open, close, and tilt the moon roof up and down.

#### ■ Opening and closing

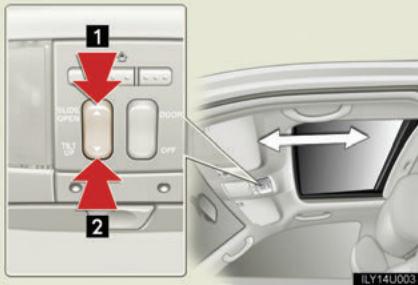

1 Open

2 Close

To stop partway, press the switch lightly.

#### ■ Tilt up and down

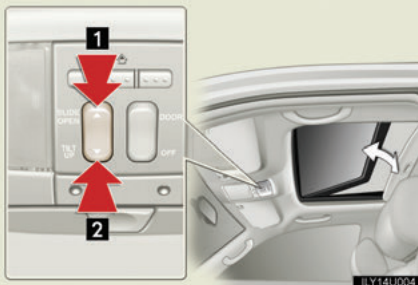

1 Tilt down

2 Tilt up

To stop partway, press the switch lightly.

### ■ The moon roof can be operated when

The ignition switch is in the "ON" position.

### ■ Linked door lock moon roof operation

- The moon roof can be opened and closed using the key. (→P. 6)
- The moon roof can be opened using the wireless remote control. (→P. 4)

### ■ Retained accessory power operation

The moon roof can be operated for approximately 45 seconds even after the ignition switch is turned to the "ACC" or "LOCK" position. It cannot, however, be operated once the driver's door is opened.

### ■ Jam protection function

If an object is detected between the moon roof and the frame while closing or tilting down, travel is stopped and the moon roof opens slightly.

### ■ If the moon roof cannot be closed automatically

Keep the switch depressed.

### ■ Sunshade

The sunshade can be opened and closed manually. However, the sunshade will open automatically when the moon roof is opened.

### ■ When the battery is disconnected

The moon roof must be initialized in order to ensure proper operation.

**STEP 1** Close the moon roof fully.

**STEP 2** Hold down the "TILT UP" button until the moon roof tilts all the way up and then tilts down a little automatically.

**STEP 3** To ensure initialization is complete, make sure automatic opening and closing functions work properly.

### ■ Customization

Settings (e.g. linked door lock operation) can be changed. (→P. 399)

 **CAUTION****■ When opening the moon roof**

Observe the following precautions.

Failing to do so may cause death or serious injury.

- Do not allow any passengers to put their hands or heads outside the vehicle while it is moving.
- Do not sit on top of the moon roof.

**■ When closing the moon roof**

Observe the following precautions.

Failing to do so may result in death or serious injury.

- Check to make sure that all passengers do not have any part of their bodies in a position where they could be caught when the moon roof is being operated.
- Do not allow children to operate the moon roof.  
Closing the moon roof on someone can cause death or serious injury.

**■ Jam protection function**

- Never try jamming any part of your body to activate the jam protection function intentionally.
- The jam protection function may not work if something gets caught just before the moon roof fully closes.

## 1-5. Refueling

### Opening the fuel tank cap

Perform the following steps to open the fuel tank cap.

#### ■ Before refueling the vehicle

Stop the engine and ensure that all the doors and windows are closed.

#### ■ Opening the fuel tank cap

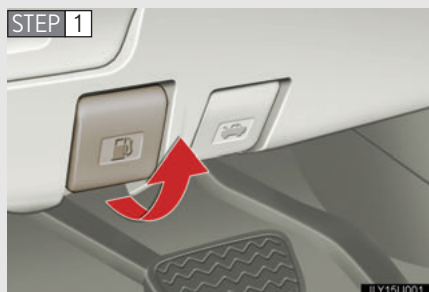

Pull the fuel filler door lever.

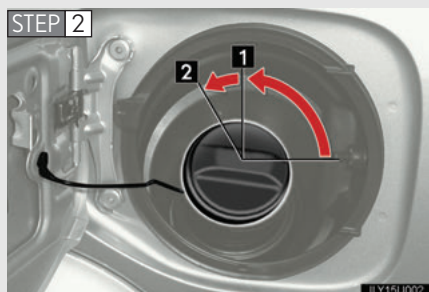

Turn the cap counterclockwise by 90 degrees (1), and then turn it an additional 30 degrees (2).

Pause briefly before removing the cap.

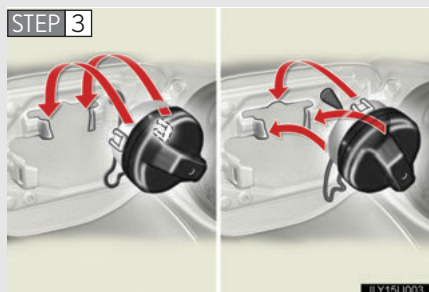

Hang the fuel tank cap on the back of the fuel filler door.

## Closing the fuel tank cap

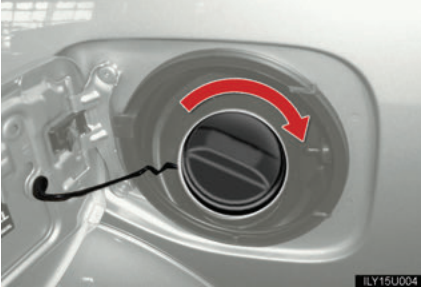

After refueling, turn the fuel tank cap clockwise until you hear a click. The cap will revolve slightly in the opposite direction once released.

1

Before driving

### ■ Fuel types

Use premium unleaded gasoline. (91 Octane Rating [Research Octane Number 96] or higher)

### ■ Fuel tank capacity

Approximately 23 gal. (87 L, 19.1 Imp. gal.)

### CAUTION

#### ■ When refueling the vehicle

Observe the following precautions while refueling the vehicle. Failure to do so, may result in death or serious injury.

- Touch the vehicle or some other metal surface to discharge any static electricity. Sparks resulting from discharging static electricity may cause the fuel vapors to ignite.
- Always hold the grips on the fuel tank cap and turn it slowly to remove it. A whooshing sound may be heard when the fuel tank cap is loosened. Wait until the sound cannot be heard before fully removing the cap. In hot weather, pressurized fuel may spray out the filler neck and cause injury.
- Do not allow anyone that has not discharged static electricity from their bodies to come close to an open fuel tank.
- Do not inhale vaporized fuel. Fuel contains substances that are harmful if inhaled.
- Do not smoke while refueling the vehicle. Doing so may cause the fuel to ignite and cause a fire.
- Do not return to the vehicle or touch any person or object that is statically charged. This may cause static electricity to build up, resulting in a possible ignition hazard.

#### ■ When replacing the fuel tank cap

Do not use anything but a genuine Lexus fuel tank cap designed for your vehicle. Failure to do so may cause a fire or other incident which may result in death or serious injury.

### NOTICE

#### ■ Refueling

Do not spill fuel during refueling.

Failing to do so may damage the vehicle, such as causing the exhaust systems to operate abnormally or damaging fuel system components or the vehicle's painted surface.



## 1-6. Theft deterrent system

# Engine immobilizer system

The vehicle's keys have built-in transponder chips that prevent the engine from starting if the key has not been previously registered in the vehicle's on-board computer.

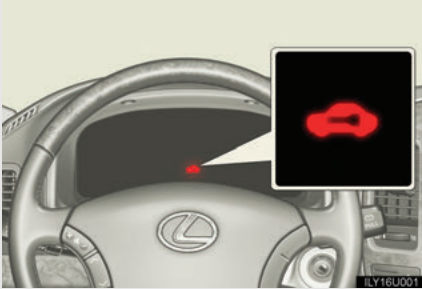

The indicator light flashes after the ignition switch has been turned to the "LOCK" position to indicate that the system is operating.

### ■ Conditions that may cause the system to malfunction

- If the grip portion of the key is in contact with a metallic object.
- If the key is in close proximity to or touching a key to the security system (key with a built-in transponder chip) of another vehicle.

### ■ Certifications for the engine immobilizer system

- ▶ For vehicles sold in the U.S.A.

FCC ID: MOZRI-20BTY

This device complies with Part 15 of the FCC Rules. Operation is subject to the following two conditions: (1) This device may not cause harmful interference, and (2) this device must accept any interference received, including interference that may cause undesired operation.

- ▶ For vehicles sold in Canada

Operation is subject to the following two conditions: (1) this device may not cause interference, and (2) this device must accept any interference, including interference that may cause undesired operation of the device.

### CAUTION

#### ■ Certifications for the engine immobilizer system

Changes or modifications not expressly approved by the party responsible for compliance could void the user's authority to operate the equipment.

### NOTICE

#### ■ For proper system operation

Do not modify, remove or disable the engine immobilizer system. If any unauthorized changes or modifications are made, the proper operation of the system cannot be guaranteed.

# Alarm

The alarm warns of forcible entry using the horn and lights.

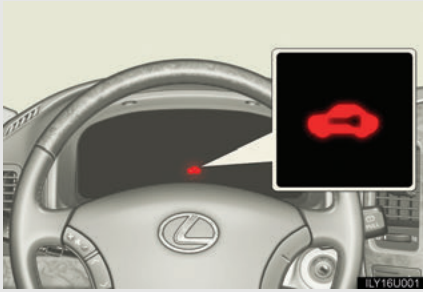

To arm the alarm, exit the vehicle, make sure that the doors and hood are closed, and lock all the doors.

The system will operate automatically once the indicator begins to flashing.

1

Before driving

### Deactivating or stopping the alarm

Do one of the following:

- Unlock the doors using the key or the wireless remote control.
- Start the engine.

#### ■ Items to check before locking the vehicle

To prevent unintended triggering of the alarm, check that there is no one in the vehicle, and that all windows and the moon roof are closed before locking the vehicle.

#### ■ When the battery is disconnected

Be sure to cancel the alarm system.

If the battery is discharged before canceling the alarm, the system may be triggered when the battery is reconnected.

### ■ Panic mode

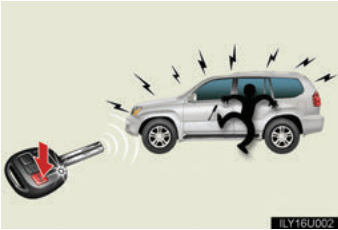

When the “PANIC” button is pushed for longer than about 1 second, the headlights/tail lights/emergency flashers will flash, the interior lights will come on, and an alarm will sound for about 60 seconds to deter any person from trying to break into or damage your vehicle.

To stop the alarm, push any button on the wireless remote control.

## 1-6. Theft deterrent system

# Theft prevention labels (U.S.A.)



These labels are attached to the vehicle to reduce vehicle theft by facilitating the tracing and recovery of parts from stolen vehicles. Do not remove under penalty of law.

1

Before driving

### Correct driving posture

Drive with a good posture as follows:

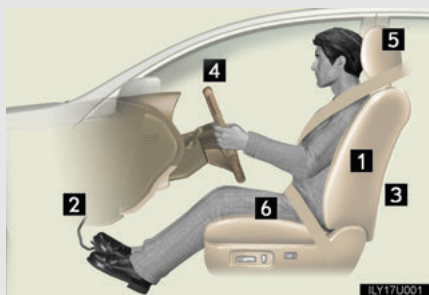

- 1 Sit upright and well back in the seat.
- 2 Adjust the position of the seat forward or backward to ensure the pedals can be reached and easily depressed to the extent required. (→P. 13)
- 3 Adjust the seatback so that the controls are easily operable.
- 4 Adjust the tilt and telescopic positions of the steering wheel downward so the air-bag is facing your chest. (→P. 35)
- 5 Lock the head restraint in place with the center of the head restraint closest to the top of your ears. (→P. 26)
- 6 Wear the seat belt correctly. (→P. 28)

 **CAUTION****■ Caution while driving**

- Do not adjust the position of the driver's seat.  
Doing so could cause the driver to lose control of the vehicle.
- Do not place a cushion between the driver or passenger and the seatback.  
A cushion may prevent correct posture from being achieved, and reduce the effectiveness of the seat belt and head restraint, increasing the risk of death or serious injury to the driver or passenger.
- Do not place anything under the front seats.  
Objects placed under the front seats may become jammed in the seat tracks and stop the seat from locking in place. This may lead to an accident. The adjustment mechanism may also be damaged.

**■ Adjusting the seat position**

- Do not recline the seat more than necessary when the vehicle is in motion, to reduce the risk of sliding under the lap belt.  
If the seat is too reclined during an accident, the lap belt may slide past the hips and apply restraint forces directly to the abdomen or your neck may contact the shoulder belt, increasing the risk of death or serious injury.
- Take care when adjusting the seat position to ensure that other passengers are not injured by the moving seat.
- Do not put your hands under the seat or near the moving parts to avoid injury.  
Fingers or hands may become jammed in the seat mechanism.

### SRS airbags

The SRS airbags inflate when the vehicle is subjected to certain types of severe impacts that may cause significant injury to the occupants. They work together with the seat belts to help reduce the risk of death or serious injury.

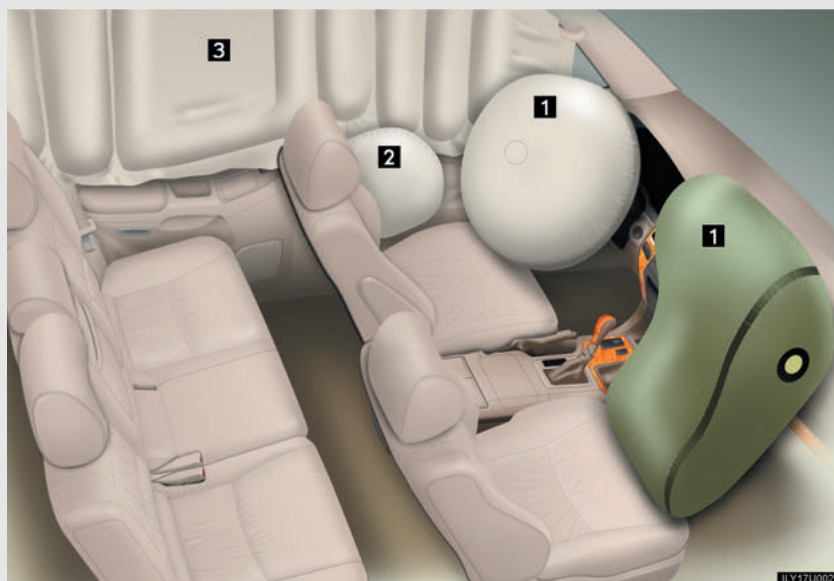

#### ► Front airbags

##### **1** Driver airbag/front passenger airbag

Can help protect the head and chest of the driver and front passenger from impact with interior components.

#### ► Side and curtain shield airbags

##### **2** Side airbag

Can help protect the torso of the front occupants.

##### **3** Curtain shield airbag

Can help protect primarily the head of front occupants and rear out-board occupants.



## Airbag system components

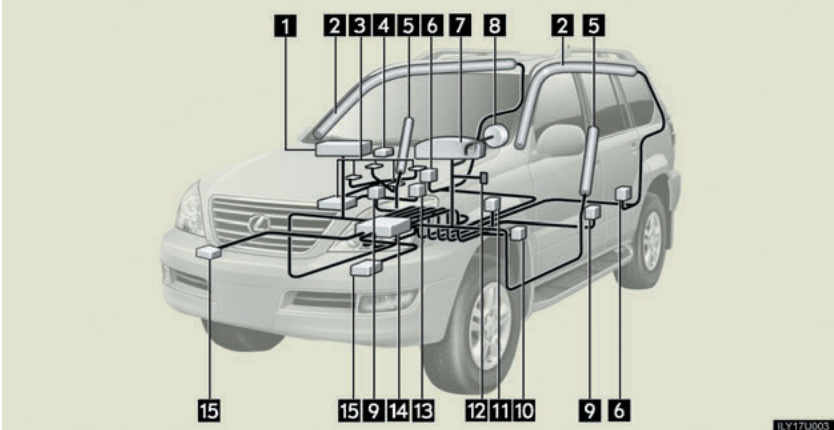

- |   |   |
|---|---|
| <b>1</b> Front passenger airbag                           | <b>8</b> Driver airbag                              |
| <b>2</b> Curtain shield airbag                            | <b>9</b> Side and curtain shield airbag sensor      |
| <b>3</b> Occupant detection system (ECU and sensors)      | <b>10</b> Driver's seat position sensor             |
| <b>4</b> "AIRBAG ON" and "AIRBAG OFF" indicator light     | <b>11</b> Driver's seat belt buckle switch          |
| <b>5</b> Side airbag                                      | <b>12</b> "RSCA OFF" switch                         |
| <b>6</b> Curtain shield airbag sensor                     | <b>13</b> Front passenger's seat belt buckle switch |
| <b>7</b> SRS warning light and "RSCA OFF" indicator light | <b>14</b> Airbag sensor assembly                    |
|   | <b>15</b> Front airbag sensor                       |

Your vehicle is equipped with "ADVANCED AIRBAGS" designed based on US motor vehicle safety standards (FMVSS208). The airbag system controls airbag deployment power for the driver and front passenger. The driver airbag system consists of the driver's seat position sensor etc. The front passenger's airbag system consists of the front passenger occupant classification sensor etc.

The main SRS airbag system components are shown above. The SRS airbag system is controlled by the airbag sensor assembly. The airbag sensor assembly consists of a safing sensor and an airbag sensor.

In certain types of severe frontal or side impacts, the SRS airbag system triggers the airbag inflators. A chemical reaction in the inflators quickly fills the airbags with non-toxic gas to help restrain the motion of the occupants.

---

### ■ If the SRS airbags deploy (inflate)

- Bruising and slight abrasions may result from contact with a deploying (inflating) SRS airbag.
- A loud noise and white powder will be emitted.
- Parts of the airbag module (steering wheel hub, airbag cover and inflator) as well as the front seats, and parts of the front pillar and roof side rail, may be hot for several minutes. The airbag itself may also be hot.
- The windshield may crack.

### ■ Operating conditions (front airbags)

- The SRS front airbags will deploy if the severity of the frontal impact is above the designed threshold level, comparable to an approximate 15 mph (25 km/h) collision when the vehicle impacts straight into a fixed barrier that does not move or deform.

However, this threshold velocity will be considerably higher if the vehicle strikes an object, such as a parked vehicle or sign pole, which can move or deform on impact, or if the vehicle is involved in an underride collision (e.g. a collision in which the front of the vehicle “underrides”, or goes under, the bed of a truck, etc.).

- It is possible that in some collisions where the forward deceleration of the vehicle is very close to the designed threshold level, the SRS front airbags and the seat belt pretensioners may not activate together.
- The SRS front passenger airbag will not activate, if there is not passenger sitting in the front passenger seat. However, the front passenger airbag may deploy, if luggage is put in the seat or the seat belt is fastened, even if the seat is unoccupied. (→P. 69)

### ■ Operating conditions (side and curtain shield airbags)

- The SRS side airbags and curtain shield airbags are designed to inflate when the passenger compartment is subjected to a severe impact from the side.
- The SRS side airbag on the passenger seat will not activate if there is no passenger sitting in the front passenger seat. However, the side airbag on the passenger seat may deploy, if luggage is put in the seat, even if the seat is unoccupied. (→P. 69)

### ■ Conditions under which the SRS airbags may deploy (inflate), other than a collision

The SRS front airbags may also deploy if a serious impact occurs to the underside of your vehicle. Some examples are shown in the illustration.

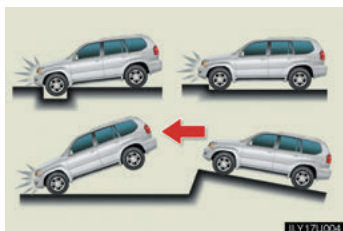

- Hitting a curb, edge of pavement or hard surface
- Falling into or jumping over a deep hole
- Landing hard or vehicle falling

The SRS curtain shield airbags may also deploy under the situations shown in the illustration.

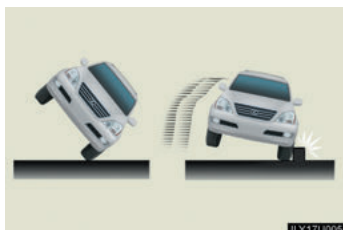

- The angle of vehicle tip-up is marginal.
- The vehicle skids and hits a curb stone.

### ■ Types of collisions that may not deploy the SRS airbag (front airbags)

The SRS front airbags are generally not designed to inflate if the vehicle is involved in a side or rear collision, if it rolls over, or if it is involved in a low-speed frontal collision. But, whenever a collision of any type causes sufficient forward deceleration of the vehicle, deployment of the SRS front airbags may occur.



- Collision from the side
- Collision from the rear
- Vehicle rollover

### ■ Types of collisions that may not deploy the SRS airbag (side and curtain shield airbags)

The SRS side airbag and curtain shield airbag system may not activate if the vehicle is subjected to a collision from the side at certain angles, or a collision to the side of the vehicle body other than the passenger compartment.

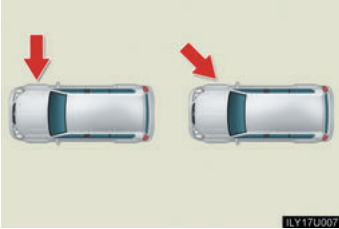

- Collision from the side to the vehicle body other than the passenger compartment
- Collision from the side at an angle

The SRS side airbags are not generally designed to inflate if the vehicle is involved in a frontal or rear collision, if it rolls over, or if it is involved in a low-speed side collision.



- Collision from the front
- Collision from the rear
- Vehicle rollover

The SRS curtain shield airbags are not generally designed to inflate if the vehicle is involved in a frontal or rear collision, if it pitches end over, or if it is involved in a low-speed side collision.

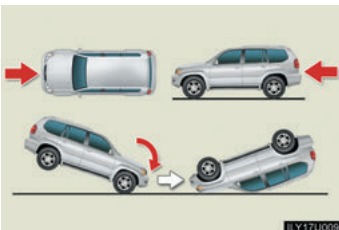

- Collision from the front
- Collision from the rear
- Pitches end over end

### ■ When to contact your Lexus dealer

In the following cases, contact your Lexus dealer as soon as possible. Do not disconnect the battery cables before contacting your Lexus dealer.

- Any of the SRS airbags have been inflated.

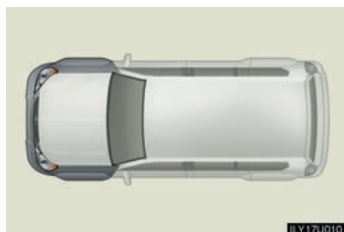

- The front of the vehicle is damaged or deformed, or was involved in an accident that was not severe enough to cause the SRS airbags to inflate.

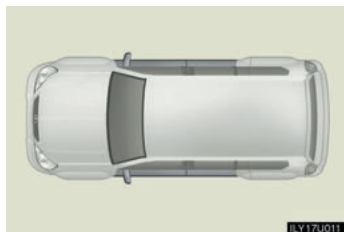

- A portion of the doors is damaged or deformed, or the vehicle was involved in an accident that was not severe enough to cause the SRS side airbags and curtain shield airbags to inflate.

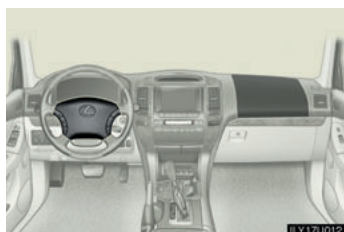

- The pad section of the steering wheel or front passenger airbag cover of the instrument panel is scratched, cracked, or otherwise damaged.



- The surface of the seats with the side airbag is scratched, cracked, or otherwise damaged.
- The portion of the front pillars, rear pillars or roof side rail garnishes (padding) containing the curtain shield airbags is scratched, cracked, or otherwise damaged.

**! CAUTION****■ SRS airbag precautions**

Observe the following precautions regarding the airbags. Failure to do so may cause death or serious injury.

- The driver and all passengers in the vehicle must wear their seat belts properly. The SRS airbags are supplemental devices to be used with the seat belts.
- The SRS driver airbag deploys with considerable force, and can cause death or serious injury especially if the driver is very close to the airbag. The National Highway Traffic Safety Administration (“NHTSA”) advises:

Since the risk zone for driver airbag is the first 2 - 3 in. (50 - 75 mm) of inflation, placing yourself 10 in. (250 mm) from your driver airbag provides you with a clear margin of safety. This distance is measured from the center of the steering wheel to your breastbone. If you sit less than 10 in. (250 mm) away now, you can change your driving position in several ways:

- Move your seat to the rear as far as you can while still reaching the pedals comfortably.
- Slightly recline the back of the seat. Although vehicle designs vary, many drivers can achieve the 10 in. (250 mm) distance, even with the driver seat all the way forward, simply by reclining the back of the seat somewhat. If reclining the back of your seat makes it hard to see the road, raise yourself by using a firm, non-slippery cushion, or raise the seat if your vehicle has that feature.
- If your steering wheel is adjustable, tilt it downward. This points the airbag toward your chest instead of your head and neck.

The seat should be adjusted as recommended by NHTSA above, while still maintaining control of the foot pedals, steering wheel, and your view of the instrument panel controls.

**! CAUTION**

**■ SRS airbag precautions**



- If the seat belt extender has been connected to the driver's seat belt buckle but the seat belt extender has not also been fastened to the latch plate of the driver's seat belt, the SRS driver's airbag system will judge that the driver is wearing the seat belt even though the seat belt has not been connected. In this case, the driver's airbag may not activate correctly in a collision, resulting in death or serious injury in the event of collision. Be sure to wear the seat belt with the seat belt extender.
- The SRS front passenger airbag also deploys with considerable force, and can cause death or serious injury especially if the front passenger is very close to the airbag. The front passenger seat should be as far from the airbag as possible with the seatback adjusted, so the front passenger sits upright.
- Improperly seated and/or restrained infants and children can be killed or seriously injured by a deploying airbag. An infant or child who is too small to use a seat belt should be properly secured using a child restraint system. Lexus strongly recommends that all infants and children be placed in the rear seats of the vehicle and properly restrained. The rear seats are the safest for infants and children. (→P. 74)

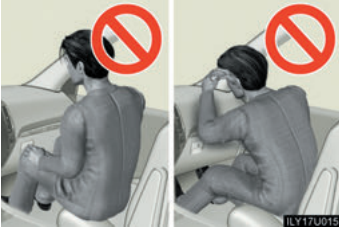

 CAUTION

 SRS airbag precautions

- Do not sit on the edge of the seat or lean against the dashboard.
- Do not allow a child sit on the knees of a front passenger while the vehicle is moving.
- Do not drive the vehicle while the driver or passenger have items resting on their knees.
- Do not lean against the door, the roof side rail or the front, side and rear pillars.
- Do not allow anyone to kneel on the passenger seat toward the door or put their head or hands outside the vehicle.

**CAUTION**

**SRS airbag precautions**



- Do not attach anything to or lean anything against areas such as the dashboard or steering wheel pad of the instrument panel. These items can become projectiles when the SRS driver and front passenger airbags deploy.
- Do not attach anything to areas such as the door, windshield glass, side door glass, front and rear pillars, roof side rail or assist grip.
- Do not hang coat hangers or other hard objects on the coat hooks. All of these items could become projectiles and seriously injure or kill you, should the SRS curtain shield airbag deploy.

- Do not use seat accessories which cover the parts where the SRS side airbags inflate as they may interfere with inflation of the airbags.
- Do not strike or apply significant levels of force to the area of the SRS airbag components shown on P. 57. Doing so can cause the SRS airbags to malfunction.
- Do not touch any of the component parts immediately after the SRS airbags have deployed (inflated) as they may be hot.
- If breathing becomes difficult after the SRS airbag has deployed, open a door or window to allow fresh air in, or leave the vehicle if it is safe to do so. Wash off any residue as soon as possible to prevent skin irritation.
- If the areas where the SRS airbags are stored, such as the steering wheel pad and front pillar garnish, are damaged or cracked, have them replaced by your Lexus dealer.

 **CAUTION****■ Modification and disposal of SRS airbag system components**

Do not dispose of your vehicle or perform any of the following modifications without consulting your Lexus dealer. The SRS airbag may malfunction or deploy (inflate) accidentally, causing death or serious injury.

- Installation, removal, disassembly and repair of the SRS airbags
- Repairs, modifications, removal or replacement of the steering wheel, instrument panel, dashboard, seats or seat upholstery, front, side and rear pillars or roof side rail
- Repairs or modifications of the front fender, front bumper, or side of the occupant compartment
- Installation of snow plows, winches, etc. to the front grille (bull bars, kangaroo bar etc.)
- Modifications to the vehicle's suspension system
- Installation of electronic devices such as mobile two-way radios or CD players
- Modifications to your vehicle for a person with a physical disability

## Deactivating the curtain shield airbags in a vehicle rollover



ON/OFF (Hold for a few seconds)

The “RSCA OFF” indicator light turns on. (Only when the ignition switch is in the “ON” position.)

### ■ The switch only should be used

In a situation where inflation is not desired (such as during extreme off-road driving).

### ■ Operating conditions when the “RSCA OFF” indicator is on

- The curtain shield airbag and seat belt pretensioner will not activate in a vehicle rollover.
- The curtain shield airbag will activate in a severe side impact.

## ⚠ CAUTION

### ■ For normal driving

Make sure the “RSCA OFF” indicator light is not turned on. If it is left on, the curtain shield airbag will not activate in the event of an accident, which may result in death or serious injury.

# Front passenger occupant classification system

Your vehicle is equipped with a front passenger occupant classification system. This system detects the conditions of the front passenger seat and activates or deactivates the devices for front passenger.



- 1 SRS warning light
- 2 Front passenger's seat belt reminder light
- 3 "AIRBAG OFF" indicator light
- 4 "AIRBAG ON" indicator light

## Condition and operation in the front passenger occupant classification system

■ Adult \*1

Indicator/ warning light	"AIRBAG ON" and "AIRBAG OFF" indicator lights	"AIRBAG ON"
	SRS warning light	Off
	Front passenger's seat belt reminder light	Flashing *2
Devices	Front passenger airbag	Activated
	Side airbag in the front passenger seat	
	Curtain shield airbag on the front passenger side	
	Front passenger's seat belt pretensioner	

### ■ Child<sup>\*3</sup> or child restraint system<sup>\*4</sup>

Indicator/ warning light	"AIRBAG ON" and "AIRBAG OFF" indicator lights	"AIRBAG OFF"* <sup>5</sup>
	SRS warning light	Off
	Front passenger's seat belt reminder light	Flashing <sup>*2</sup>
Devices	Front passenger airbag	Deactivated
	Side airbag in the front passenger seat	
	Curtain shield airbag on the front passenger side	Activated
	Front passenger's seat belt pretensioner	

### ■ Unoccupied

Indicator/ warning light	"AIRBAG ON" and "AIRBAG OFF" indicator lights	Not illumi- nated
	SRS warning light	Off
	Front passenger's seat belt reminder light	
Devices	Front passenger airbag	Deactivated
	Side airbag in the front passenger seat	
	Curtain shield airbag on the front passenger side	Activated
	Front passenger's seat belt pretensioner	Deactivated

## ■ System malfunction

Indicator/ warning light	“AIRBAG ON” and “AIRBAG OFF” indicator lights	“AIRBAG OFF”
	SRS warning light	On
	Front passenger’s seat belt reminder light	Off
Devices	Front passenger airbag	Deactivated
	Side airbag in the front passenger seat	
	Curtain shield airbag on the front passenger side	Activated
	Front passenger’s seat belt pretensioner	

- \*1: The system judges a person of adult size as an adult. When a smaller adult sits in the front passenger seat, the system may recognize him/her as a child depending on his/her physique and posture.
- \*2: In the event the front passenger does not wear a seat belt.
- \*3: When a large child who has outgrown a child restraint system sits in the front passenger seat, the system may recognize him/her as an adult depending on his/her physique and posture.
- \*4: Never install a rear-facing child restraint system on the front passenger seat. A forward-facing child restraint system should only be installed on the front passenger seat when it is unavoidable.  
(→P. 77)
- \*5: In case indicator is not illuminated, consult this manual as for installing the child restraint system properly. (→P. 74)

### CAUTION

#### ■ Front passenger occupant classification system precautions

Observe the following precautions regarding the front passenger occupant classification system.

- Wear the seat belt properly.
- Make sure the front passenger's seat belt tab has not been left inserted into the buckle before someone sits in the front passenger seat.
- Make sure the "AIRBAG OFF" indicator light is not illuminated when using the seat belt extender for the front passenger seat. If the "AIRBAG OFF" indicator light is illuminated, disconnect the extender tongue from the seat belt buckle, then reconnect the seat belt. Reconnect the seat belt extender after making sure the "AIRBAG ON" indicator light is illuminated. If you use the seat belt extender while the "AIRBAG OFF" indicator light is illuminated, the front passenger airbag and side airbag on the front passenger side may not activate correctly, which could cause death or serious injury in the event of a collision.
- Do not apply a heavy load to the front passenger seat or equipment (e.g. arm-rest).
- Do not put weight on the front passenger seat by putting your hands or feet on the front passenger seat seatback from the second seat.
- Do not let a second seat passenger lift the front passenger seat with their feet or press on the seatback with their legs.
- Do not put objects under the front passenger seat.
- Do not recline the front passenger seatback so far that it touches a rear seat. This may cause the "AIRBAG OFF" indicator light to be illuminated, which indicates that the passenger's airbags will not deploy in the event of a severe accident. If the seatback touches the rear seat, return the seatback to a position where it does not touch the rear seat. Keep the front passenger seatback as upright as possible when the vehicle is moving. Reclining the seatback excessively may lessen the effectiveness of the seat belt system.



 CAUTION**■ Front passenger occupant classification system precautions**

- If an adult sits in the front passenger seat, the “AIRBAG ON” indicator light is illuminated. If the “AIRBAG OFF” indicator is illuminated, ask the passenger to sit up straight, well back in the seat, feet on the floor, and with the seat belt worn correctly. If the “AIRBAG OFF” indicator still remain illuminated, either ask the passenger to move to the rear seat, or if that is not possible, move the front passenger seat fully rearward.
- When it is unavoidable to install a forward-facing child restraint system on the front passenger seat, install the child restraint system on the front passenger seat in the proper order. (→P. 77)
- Do not remove the front seat.
- Do not kick the front passenger seat or subject it to severe impact. Otherwise, the SRS warning light may come on to indicate a malfunction in the detection system. In this case, contact your Lexus dealer immediately.
- Do not use a seat accessory, such as a cushion or seat cover, that covers the seat cushion surface.
- Child restraint systems installed on the second seat should not contact the front seatbacks.

## 1-7. Safety information

# Child restraint systems

A child restraint system for a small child or baby must itself be properly restrained on the seat with the lap portion of the lap/shoulder belt.

The laws of all 50 states of the U.S.A. and Canada now require the use of child restraint systems.

### Points to remember

Studies have shown that installing a child restraint on a rear seat is much safer than installing one to the front passenger seat.

- Choose a child restraint system appropriate to the age and size of the child.
- For installation details, follow the instructions provided with the child restraint system.  
General installation instructions are provided in this manual. (→P. 77)

### Types of child restraints

Child restraint systems are classified into the following 3 types according to the age and size of the child.

#### ► Infant seat



▶ Convertible seat



▶ Booster seat



■ When the child restraint system is not in use

Leave the child restraint system properly secured on the seat. Do not store the restraint loosely on a passenger seat or in the luggage compartment.

■ Selecting an appropriate child restraint system

Get an appropriate child restraint system for the child. If a child is too large for a child restraint system, sit the child on a rear seat and use the vehicle's seat belt. (→P. 28)

 CAUTION

■ Child restraint precautions

- For effective protection in automobile accidents and sudden stops, a child must be properly restrained, using a seat belt or child restraint system depending on the age and size of the child. Holding a child in your arms is not a substitute for a child restraint system. In an accident, the child can be crushed against the windshield, or between you and the vehicle's interior.
- Lexus strongly urges the use of a proper child restraint system that conforms to the size of the child, installed on the rear seat. According to accident statistics, the child is safer when properly restrained in the rear seat than in the front seat.
- Never install a rear-facing child restraint system on the front passenger seat even if the "AIRBAG OFF" indicator light is illuminated. In the event of an accident, the force of the rapid inflation of the front passenger airbag can cause death or serious injury to the child if the rear-facing child restraint system is installed on the front passenger seat.
- A forward-facing child restraint system should allowed to be installed on the front passenger seat only when it is unavoidable. Always move the seat as far back as possible even if the "AIRBAG OFF" indicator light is illuminated, because the front passenger airbag could inflate with considerable speed and force. Otherwise, the child may be killed or seriously injured.
- Do not use the seat belt extender when installing a child restraint system on the front or rear passenger seat. If installing a child restraint system with the seat belt extender connected to the seat belt, the seat belt will not securely hold the child restraint system, which could cause death or serious injury to the child or other passengers in the event of collision.
- Do not allow the child to lean his/her head or any part of his/her body against the door or the area of the seat, front pillar or roof side rail from which the side airbags or curtain shield airbags deploy even if the child is seated in the child restraint system. It is dangerous if the side airbags and curtain shield airbags inflate, and the impact could cause death or serious injury to the child.
- Make sure you have complied with all installation instructions provided by the child restraint manufacturer and that the system is properly secured. If it is not secured properly, it may cause death or serious injury to the child in the event of a sudden stop or accident.

## Installing child restraints

Follow the child restraint system manufacturer's instructions. Firmly secure the child restraint using the seat belt. If using the lower anchorages, use the top strap as well, and be sure to secure both firmly.



- 1** Seat belts equipped with a child restraint locking mechanism (ALR/ELR belts except driver's seat belt) (→P. 31)



- 2** Child restraint lower anchorages

Lower anchorages are provided for the right side seat and between the center and left side seats. (Buttons displaying the location of the anchorages are attached to the seats.)



- 3** Anchor bracket (for top strap)

Anchor brackets are provided for all second seats.

## Installing child restraints using a seat belt (child restraint lock function belt)

### ■ Rear facing child seat — Infant/convertible

STEP 1

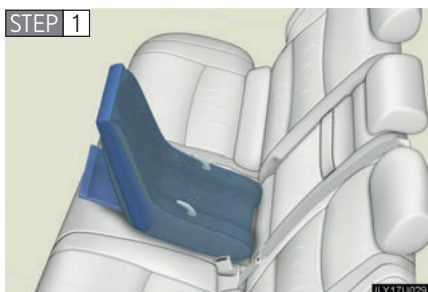

Place the child seat on the rear seat facing the rear of the vehicle.

STEP 2

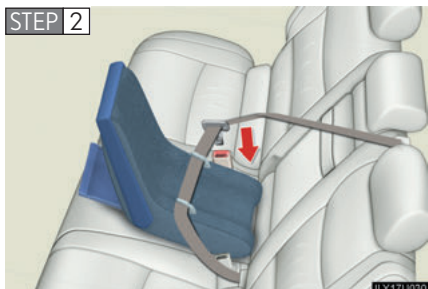

Run the seat belt through the infant seat and insert the plate into the buckle. Make sure that the belt is not twisted.

STEP 3

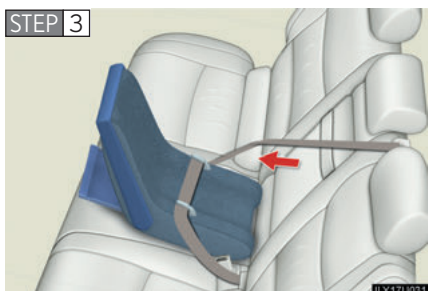

Fully extend the shoulder belt and then allow it to retract slightly in order to activate the ALR lock mode.

Lock mode allows the seat belt to retract only.

STEP 4

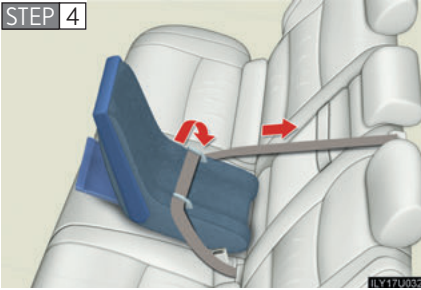

While pushing the child seat down into the seat, allow the shoulder belt to retract until the child seat is securely in place.

After the shoulder belt has retracted to a point where there is no slack in the belt, pull the belt to check that it cannot be extended.

### ■ Forward facing — Convertible child seat

STEP 1



Place the child seat on the seat facing the front of the vehicle.

STEP 2

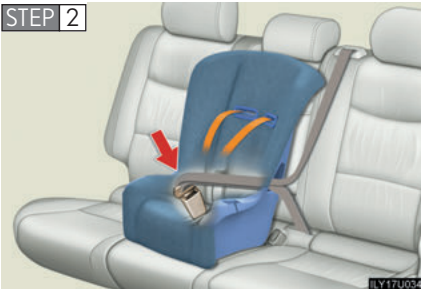

Run the seat belt through the child seat and insert the plate into the buckle. Make sure that the belt is not twisted.

STEP 3

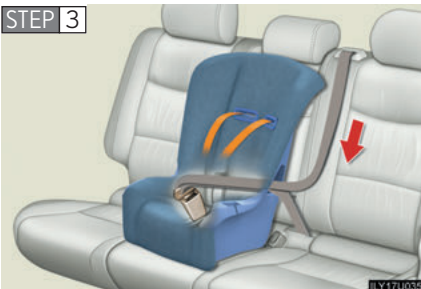

Fully extend the shoulder strap and then allow it to retract slightly into the ALR lock mode.

Lock mode allows the seat belt to retract only.

1

Before driving

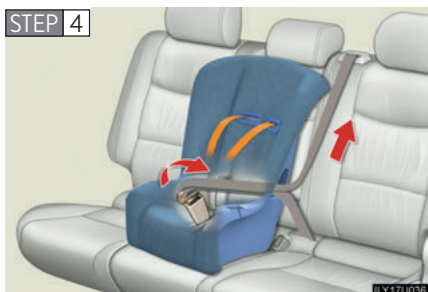

While pushing the child seat into the seat, allow the shoulder belt to retract until the child seat is securely in place.

After the shoulder belt has retracted to a point where there is no slack in the belt, pull the belt to check that it cannot be extended.

### ■ Booster seat



Place the child seat on the seat facing the front of the vehicle.



Sit the child in the child seat. Fit the seat belt to the child seat according to the manufacturer's instructions and insert the plate into the buckle. Make sure that the belt is not twisted.

Check that the shoulder belt is correctly positioned over the child's shoulder, and that the lap belt is as low as possible. (→P. 28)



## Removing a child restraint installed with a seat belt

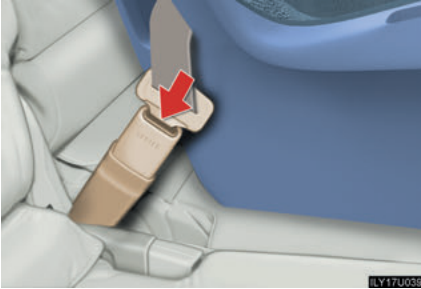

Push the buckle release button and fully retract the seat belt.

1

Before driving

## Installation with child restraint lower anchorages

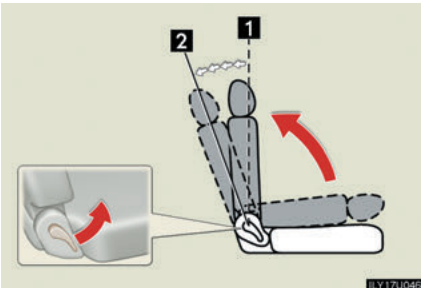

Fold the seatback forward and then back to the 1st lock position (most upright position) until it locks into place. Adjust the seatback to the 5th lock position.

- 1** 1st lock position
- 2** 5th lock position

► Type A

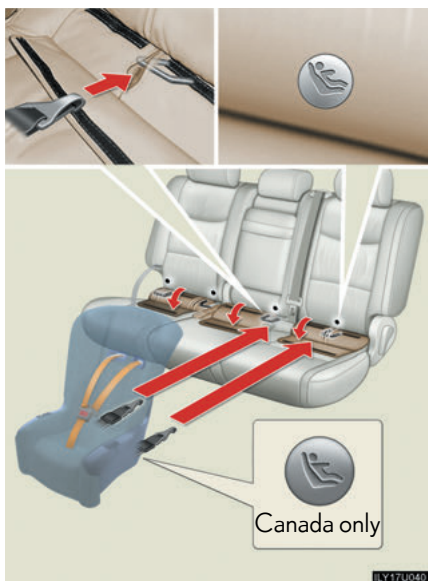

**STEP 1** Widen the gap between the seat cushion and seat-back slightly.

**STEP 2** Latch the hooks of the lower straps onto the anchorages.

If the child restraint has a top strap, the top strap should be latched onto the anchorage.

For owners in Canada:  
The symbol on a child restraint system indicates the presence of a lower anchorage system.

► Type B

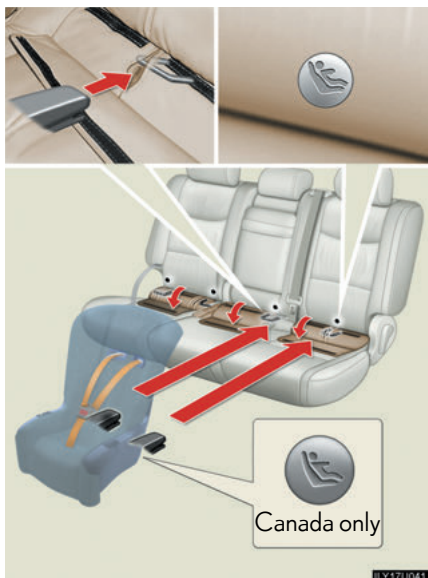

**STEP 1** Widen the gap between the seat cushion and seat-back slightly.

**STEP 2** Latch the buckles onto the anchorages.

If the child restraint has a top strap, the top strap should be latched onto the anchorage.

For owners in Canada:  
The symbol on a child restraint system indicates the presence of a lower anchorage system.

## Child restraint systems with a top strap

STEP 1



Secure the child restraint using a seat belt or lower anchors, and remove the head restraint.

STEP 2



Open the anchor bracket cover, latch the hook onto the anchor bracket and tighten the top strap.

Make sure the top strap is securely latched.

STEP 3

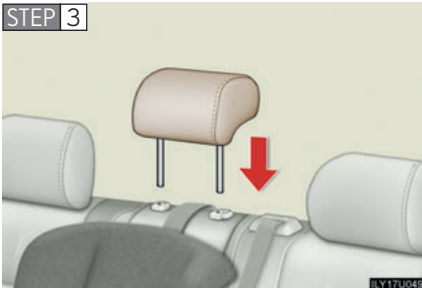

Reinstall the head restraint.

### ■ Laws and regulations pertaining to anchorages

Anchorage conform to FMVSS225 or CMVSS210.2.

Child restraint systems conforming to FMVSS213 or CMVSS213 specifications can be used.

This vehicle is designed to conform to the SAE J1819.

1

Before driving

**! CAUTION**

■ **When installing a booster seat**

Do not fully extend the shoulder belt to prevent the belt from going to ALR lock mode: (→P. 31)

- ALR mode causes the belt to tighten only which could cause injury or discomfort to the child.
- Do not allow the child to play with the seat belt or the child could be killed or seriously injured.

■ **When installing a child restraint system**

Follow the directions given in the child restraint system installation manual and fix the child restraint system securely in place.

If the child restraint system is not correctly fixed in place, the child may be injured or even killed in the event of sudden braking or an accident.



- If the driver's seat interferes with the child restraint system and prevents it from being attached correctly, attach the child restraint system to the right-hand rear seat.



- Only put a forward facing or booster child seat on the front seat when unavoidable. When installing a forward facing or booster child restraint on the front passenger seat, move the seat as far back as possible even if the "AIRBAG OFF" indicator light is illuminated. Failing to do so may result in death or serious injury if the airbags deploy (inflate).

**! CAUTION****■ When installing a child restraint system**

- When installing a child restraint system in the third center position, set the both seat-backs to the same angle. Otherwise, the child restraint system cannot be properly secured.

- When a booster seat is installed, always ensure that the shoulder belt is positioned across the center of the child's shoulder. The belt should be kept away from the child's neck, but not so that it could fall off the child's shoulder. Failing to do so may result in death or serious injury in the event of an accident or sudden braking.
- Ensure the belt and tab are securely locked and that the seat belt is not twisted.
- Push and pull the child seat in different directions to be sure it is secure.
- Follow all installation instructions provided by the child restraint system manufacturer.

**■ Do not use a seat belt extender**

If a seat belt extender is used when installing a child restraint system, the seat belt will not securely hold the child restraint system, which could cause death or serious injury to the child or other passengers in the event of a collision.

**CAUTION**

**■ To correctly attach a child restraint system to the anchorages**

- When using the lower anchorages, be sure that there are no foreign objects around the anchorages and that the seat belt is not caught behind the child seat. Make sure the child restraint system is securely attached, or it may cause death or serious injury to the child in the event of a sudden stop or accident.



- When using the left side lower anchorages for the child restraint system, do not sit in the center seat. Seat belt function may be impaired, such as being positioned overly high or loose-fitting, which may result in death or serious injury in the event of a collision.

<b>2-1. Driving procedures</b> .....	<b>88</b>	<b>2-3. Operating the lights and</b>	
Driving the vehicle.....	88	windshield wipers.....	111
Starting the engine.....	95	Headlight switch.....	111
Automatic transmission.....	98	Fog light switch.....	113
Turn signal lever.....	101	Windshield wipers and	
Parking brake.....	102	washer.....	114
<b>2-2. Instrument cluster</b> .....	<b>103</b>	Rear window wiper and	
Gauges and meters.....	103	washer.....	117
Indicators and warning		<b>2-4. Using other driving</b>	
lights.....	105	<b>systems</b> .....	<b>118</b>
Trip information display.....	108	Cruise control.....	118
		Four-wheel drive system.....	121
		Rear height control air	
		suspension.....	123
		Electronic modulated	
		suspension.....	129
		DAC (Downhill Assist	
		Control system).....	130
		Driving assist systems.....	132
		<b>2-5. Driving information</b> .....	<b>135</b>
		Off-road precautions.....	135
		Cargo and luggage.....	140
		Vehicle load limits.....	144
		Winter driving tips.....	146
		Trailer towing.....	150
		Dinghy towing.....	160

## 2-1. Driving procedures

# Driving the vehicle

The following procedures should be observed to ensure safe driving.

### ■ Starting the engine (→P. 95)

#### ■ Driving

**STEP 1** With the brake pedal depressed, shift the shift lever to “D”.  
(→P. 98)

**STEP 2** Release the parking brake. (→P.102)

**STEP 3** Gradually release the brake pedal and gently push the accelerator pedal to accelerate the vehicle.

#### ■ Stopping

**STEP 1** With the shift lever in “D”, push the brake pedal.

**STEP 2** If necessary, set the parking brake.

When the vehicle is stopped for an extended period of time, shift the shift lever to “P” or “N”.  
(→P.98)

#### ■ Parking the vehicle

**STEP 1** With the shift lever in “D”, push the brake pedal.

**STEP 2** Set the parking brake. (→P.102)

**STEP 3** Shift the shift lever to “P”. (→P.98)

**STEP 4** Turn the ignition switch to stop the engine.

**STEP 5** Lock the door, making sure that you have the key on your person.

### Starting on a steep incline

**STEP 1** Firmly set the parking brake and shift the shift lever to “D”.

**STEP 2** Gently depress the accelerator pedal.

**STEP 3** Release the parking brake.



---

### ■ Breaking in your new Lexus

To extend the life of the vehicle, the following precautions are recommended to observe:

- For the first 200 miles (300 km):  
Avoid sudden stops.
- For the first 500 miles (800 km):  
Do not tow a trailer.
- For the first 600 miles (1000 km):
  - Do not drive at extremely high speeds.
  - Avoid sudden acceleration.
  - Do not drive continuously in the low gears.
  - Do not drive at a constant speed for extended periods.

### ■ Operating your vehicle in a foreign country

Comply with the relevant vehicle registration laws and confirm the availability of the correct fuel. (→P. 380)

### CAUTION

#### ■ When starting the vehicle

Always keep your foot on the brake pedal while stopped with the engine running. This prevents the vehicle from creeping.

#### ■ When driving the vehicle

- Do not drive if you are unfamiliar with the location of the brake and accelerator pedals to avoid depressing the wrong pedal.  
Accidentally depressing the accelerator pedal instead of the brake pedal will result in sudden acceleration that may lead to an accident that could result in death or serious injury.
- Do not drive the vehicle over or stop the vehicle near flammable materials.
- Do not let the vehicle roll backwards while the shift lever is in a driving position, or roll forward while the shift lever is in "R".  
Doing so may cause the engine not to operate or lead to poor brake and steering performance, resulting in an accident or damage to the vehicle.
- If the smell of exhaust is noticed inside the vehicle, open the windows and check that the back door is closed.  
Large amounts of exhaust in the vehicle can cause driver drowsiness and eventually, death. Have the cause of the problem inspected immediately.
- Do not under any circumstances shift the shift lever to "P", "R" or "N" while the vehicle is moving.  
Doing so can cause significant damage to the transmission and may result in a loss of vehicle control.
- Do not shift the shift lever to "N" while the vehicle is moving.  
Doing so may cause the engine brake not to operate properly and lead to an accident.
- Do not turn the engine off while driving.  
The power steering and brake booster systems will not operate properly if the engine is off.

 **CAUTION****■ When driving the vehicle**

- Use engine braking (downshift) to maintain a safe speed when driving down a steep hill.  
Using the brakes continuously may cause the brakes to overheat and lose effectiveness. (→P. 100)
- When stopped on an inclined surface, use the brake pedal and parking brake to prevent the vehicle from rolling backward or forward and causing an accident.
- Be careful when driving on slippery surfaces, as the vehicle may spin or skid when downshifting, rapidly accelerating, braking or turning.
- Do not adjust the position of the steering wheel, the seat, or the inside or outside rear view mirrors while driving.  
Doing so may result in a loss of vehicle control that can cause accidents that may result in death or serious injury.
- Always check that all passengers' arms, heads or other parts of their bodies are not outside the vehicle, as this may result in death or serious injury.
- Do not drive in excess of the speed limit. Even if the legal speed limit permits it, do not drive over 85 mph (140 km/h) unless your vehicle has high-speed capability tires. Driving over 85 mph (140 km/h) may result in tire failure, loss of control and death or serious injury. Be sure to consult a tire dealer to determine whether the tires on your vehicle are high-speed capability tires or not before driving at such speeds.
- If you drive through deep water over about 20 in. (500 mm) in depth, put the vehicle height in the "H" mode using the active height select switch and then turn off the active height control suspension by pushing the height control switch. Drive your vehicle at 19 mph (30 km/h) or less.

### CAUTION

#### ■ When shifting the shift lever

Be careful not to shift the shift lever with the accelerator pedal depressed.

This may lead to unexpected rapid acceleration of the vehicle that may cause an accident and result in death or serious injury.

#### ■ When the vehicle is stopped

- Do not race the engine.

If the vehicle is in any gear other than “P” or “N” the vehicle may accelerate suddenly and unexpectedly, and may cause an accident.

- Do not leave the vehicle with the engine running for a long time.

If such a situation cannot be avoided, park the vehicle in an open space and check that exhaust fumes do not enter the vehicle interior.

- Always keep a foot on the brake pedal while the engine is running to prevent an accident caused by the vehicle moving.

#### ■ When the vehicle is parked

- Do not leave glasses, cigarette lighters, spray cans, or soft drink cans in the vehicle when it is in the sun.

Failure to do so may result in the following:

- Gas may leak from a cigarette lighter or spray can, and may lead to a fire.
- The temperature inside the vehicle may cause the plastic lenses and plastic material of eye glasses to deform or crack.
- Soft drink cans may fracture, causing the contents to spray over the interior of the vehicle, and may also cause a short circuit in the vehicle's electrical components.

- Always apply the parking brake, shift the shift lever to “P”, stop the engine and lock the vehicle.

Do not leave the vehicle unattended while the engine is running.

- Do not touch the exhaust pipe while the engine is running or immediately after turning the engine off.

Doing so may cause burns.

- Do not leave the engine running in an area with snow build up, or where snow is expected to fall.

Exhaust gases may enter the vehicle and cause gas poisoning.

 **CAUTION****■ When taking a nap in the vehicle**

Always turn the engine off.

Otherwise, you may accidentally move the shift lever or press the accelerator pedal, which could cause an accident or fire due to abnormal engine overheating. Additionally, if the vehicle is parked in a poorly ventilated area, exhaust fumes may enter the vehicle and cause gas poisoning.

**■ When braking the vehicle**

- When the brakes are wet, drive more cautiously.

Braking distance increases when the brakes are wet, and may cause one side of the vehicle to brake differently than the other side. Also the parking brake may not securely hold the vehicle.

- If the power brake assist function does not operate, do not follow other vehicles closely and avoid downhill or sharp turns that require braking.

In this case, braking is still possible, but it will require more force on the pedal than usual. Braking distance may also increase.

- Do not pump the brake pedal if the engine stalls.

Each push on the pedal uses up your reserved brake fluid pressure.

- The brake system consists of 2 individual hydraulic systems: if one of the systems fails, the other will still operate. In this case, the brake pedal should be depressed more firmly than usual and braking distance becomes longer.

Do not drive your vehicle with only a single brake system. Have your brakes fixed immediately.

### NOTICE

#### ■ While driving the vehicle

Do not use the accelerator pedal or depress accelerator and brake pedals together to hold the vehicle on a hill.

#### ■ When parking the vehicle

Always put the shift lever in "P". Failure to do so may cause the vehicle to move or the vehicle may accelerate suddenly if the accelerator pedal is accidentally depressed.

#### ■ Avoiding damage to vehicle parts

- Do not turn the steering wheel fully in either direction and hold it there for a long time.

Doing so may damage the power steering pump.

- When driving over bumps in the road, drive as slowly as possible to avoid damaging the wheels, underside of the vehicle, etc.

#### ■ If you hear a squealing or scraping noise (brake pad wear limit indicators)

Have your Lexus dealer check and replace the brake pads as soon as possible.

The rotor damage can result if the pads are not replaced when needed.

#### ■ If you get a flat tire while driving

A flat or damaged tire may cause the following situations. Hold the steering wheel firmly and gradually press the brake pedal to slow down the vehicle.

- It may be difficult to control your vehicle.

- The vehicle will make abnormal sounds.

- The vehicle will behave abnormally.

Replace a flat tire with a new one. (→P. 356)

## 2-1. Driving procedures

# Starting the engine

### ■ Ignition switch



#### 1 "LOCK":

The steering wheel is locked and the key can be removed.

#### 2 "ACC":

Some electrical components such as the audio system can be used.

#### 3 "ON":

All electrical components can be used.

#### 4 "START":

For starting the engine.

### ■ Starting the engine

- STEP 1** Check that the parking brake is set.
- STEP 2** Turn off unnecessary lights and accessories.
- STEP 3** Check that the shift lever is set in "P".
- STEP 4** Sit in the driver's seat and firmly depress the brake pedal.
- STEP 5** Turn the ignition switch to the "START" position to start the engine.

### ■ Turning the key from "ACC" to "LOCK"



**STEP 1** Shift the shift lever to "P".

**STEP 2** Push in the key and turn to the "LOCK" position.

### ■ Steering lock release

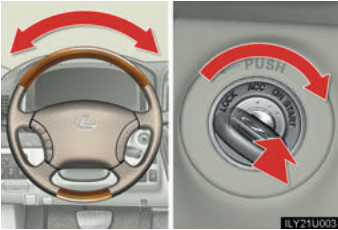

When starting the engine, the ignition switch may seem stuck in the “LOCK” position. To free it, turn the ignition key while turning the steering wheel slightly in either direction.

### ■ Starting the engine using the flat key

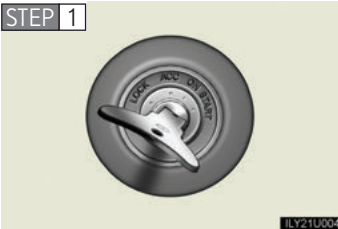

Remove the flat key from its case. Insert the key into the ignition switch.

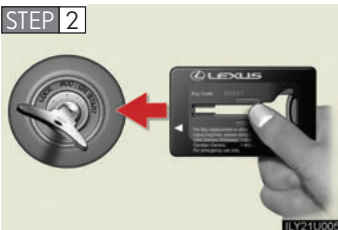

Bring the key case close to the ignition switch within 10 seconds as indicated by an arrow.

**STEP 3** Put the key case away when the security indicator light goes out. This means the engine immobilizer system has turned off.

**STEP 4** Start the engine within 60 seconds after the security indicator light goes off.

### ■ Leak detection pump

Several hours after the engine is turned off, you may hear a sound coming from underneath the luggage compartment for several minutes. This is normal operation and does not indicate a malfunction.



 **CAUTION**
**■ When starting the engine**

Always start the engine while sitting in the driver's seat. Do not press the accelerator pedal while starting the engine under any circumstances.

Doing so may cause an accident resulting in death or serious injury.

**■ Caution while driving**

Do not turn the ignition switch to the "LOCK" position.

If in an emergency, you must turn the engine off while the vehicle is moving, turn the key to only to the "ACC" position.

 **NOTICE**
**■ To prevent battery discharge**

Do not leave the ignition key in the "ACC" or "ON" position for long periods without the engine running.

**■ When starting the engine**

● Do not race the cold engine.

● If the engine becomes difficult to start or stalls frequently, have the engine checked immediately.

## 2-1. Driving procedures

# Automatic transmission

Select a shift position appropriate for the driving conditions.

### ■ Shifting the shift lever

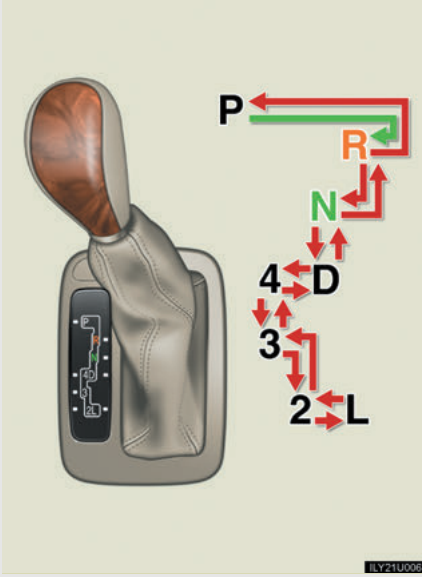

← While the ignition switch is in the "ON" position, depress the brake pedal and move the shift lever.

### ■ Shift position uses

Shift position	Function
P	Parking the vehicle or starting the engine
R	Reversing
N	Neutral
D	Normal driving*
4	Position for moderate engine braking
3, 2	Position for more powerful engine braking
L	Position for maximum engine braking

\*: To improve fuel consumption and reduce noises, set the shift lever in the "D" position for normal driving.

### ■ Selecting second start mode

Use the second start mode for accelerating and driving on slippery road surfaces, such as on snow.



Press the "2nd STRT" switch.

To cancel the mode, press the switch again.

### ■ Downshifting restrictions

Keep the engine rpm from going into the red zone. The maximum allowable speed is as follows:

Downshifting	Transfer position	Maximum speed mph (km/h)
4→3	“H”	86 (139)
	“L”	33 (54)
3→2	“H”	58 (94)
	“L”	22 (36)
2→L	“H”	24 (40)
	“L”	9 (15)

### ■ When driving with the cruise control system

The engine brake will not operate when downshifting from “D” to “4”. (→P. 118)

### ■ If the shift lever cannot be shifted from “P”

→P. 368

## 2-1. Driving procedures

# Turn signal lever

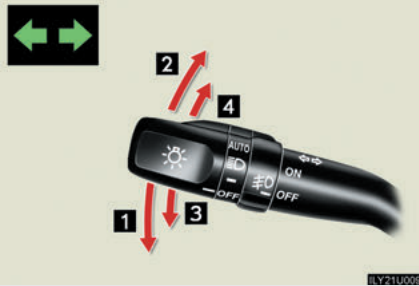

- 1 Left turn  
The left hand signal will flash until you release the lever.
- 2 Right turn  
The right hand signal will flash until you release the lever.
- 3 Move and hold the lever part-way to signal a lane change  
The left hand signal will flash until you release the lever.
- 4 Move and hold the lever part-way to signal a lane change  
The right hand signal will flash until you release the lever.

2

When driving

### ■ Turn signals can be operated when

The ignition switch is in the “ON” position.

### ■ If the indicators flash faster than usual

Check that a light bulb in the front or rear turn signal lights has not burned out.

## 2-1. Driving procedures

# Parking brake

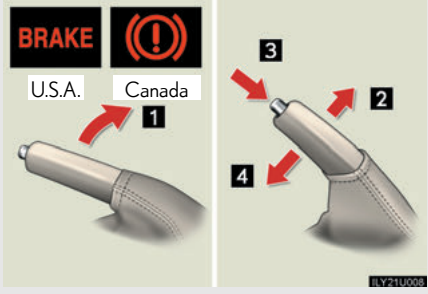

**1** Sets the parking brake  
Fully set the parking brake while depressing the brake pedal

**2 3 4** Releases the parking brake

### NOTICE

#### ■ Before driving

Fully release the parking brake.

Driving the vehicle with the parking brake set will lead to brake components overheating, which may affect braking performance and increase brake wear.

## 2-2. Instrument cluster

# Gauges and meters



The units used on the speedometer may differ depending on the target region.

The following gauges and meters illuminate when the ignition switch is in the “ON” position.

### 1 Fuel gauge

Displays the quantity of fuel remaining in the tank.

### 2 Speedometer

Displays the vehicle speed.

### 3 Tachometer

Displays the engine speed in revolutions per minute.

### 4 Engine coolant temperature gauge

Displays the engine coolant temperature.

### 5 Odometer/trip meter and trip meter reset knob

Switches between odometer and trip meter displays. Pushing and holding the knob will reset the trip meter when the trip meter is being displayed.

### 6 Odometer

Displays the total distance the vehicle has been driven.

### Trip meter

Displays the distance the vehicle has been driven since the meter was last reset. Trip meters A and B can be used to record and display different distances independently.

## Instrument panel light control

The brightness of the instrument panel lights can be adjusted.



1 Brighter

2 Darker

### NOTICE

#### ■ To prevent damage to the engine and its components

- Do not let the indicator needle of the tachometer enter the red zone, which indicates the maximum engine speed.
- The engine may be overheating if the engine coolant temperature gauge is in the red zone ("H"). In this case, immediately stop the vehicle in a safe place. Check the engine after it has cooled completely. (→P. 373)



## 2-2. Instrument cluster

### Indicators and warning lights

The indicator and warning lights on the instrument cluster and center panel inform the driver of the status of the vehicle's various systems.

#### ► Instrument cluster



The units used on the speedometer and some indicators may differ depending on the target region.

#### ► Center panel



**■ Indicators**

The indicators inform the driver of the operating state of the vehicle's various systems.



Turn signal indicator  
(→P. 101)



Headlight high beam indicator (→P. 111)



(U.S.A.)

Headlight indicator  
(→P. 111)



(Canada)

Tail light indicator  
(→P. 111)



Security indicator  
(→P. 49)



Shift position indicators  
(→P. 99)



\*

Height control indicator  
(→P. 123)



Automatic transmission second start indicator  
(→P. 99)



Cruise control indicator  
(→P. 118)



\*

"RSCA OFF" indicator  
(→P. 68)



\*

Downhill assist control system indicator  
(→P. 130)



\*

(U.S.A.)

Engine oil replacement reminder light (→P. 350)



\*

Slip indicator  
(→P. 133)



"VSC OFF" indicator  
(→P. 121)



Center differential lock indicator (→P. 121)



\*

"AIRBAG ON" indicator  
(→P. 69)



\*

"AIRBAG OFF" indicator  
(→P. 69)

## ■ Warning lights

Warning lights inform the driver of malfunctions in the indicated vehicle's systems. (→P. 347)

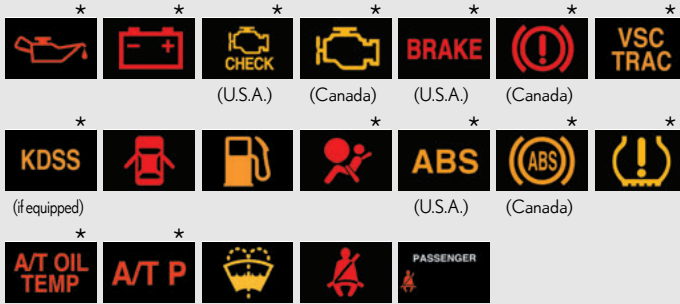

\*: These lights turn on when the ignition switch is turned to the “ON” position to indicate that a system check is being performed. They will turn off after the engine is running, or after a few seconds. There may be a malfunction in a system if the lights do not come on, or turn off. Have the vehicle inspected by your Lexus dealer.

## ⚠ CAUTION

### ■ If a safety system warning light does not come on

Should a safety system light such as ABS and the SRS airbag warning light not come on when you turn the ignition switch to the “ON” position, this could mean that these systems are not available to help protect you in an accident, which could result in death or serious injury. Have the vehicle inspected by your Lexus dealer immediately if this occurs.

## 2-2. Instrument cluster

### Trip information display

The trip information display presents the driver with a variety of driving-related data.

#### ► Trip information display



- Clock(→P. 235)
- Outside temperature display (→P. 236)
- Average fuel consumption
- Current fuel consumption
- Driving range
- Average vehicle speed
- Barometer
- Altimeter
- Driving time

Display items can be switched by pushing the “MODE” button.



### Display light control

Push and hold the “MODE” button until “ILL” appears on the display. Push “▲” or “▼” to adjust the brightness.

You can adjust the brightness to 3 levels (when the tail lights are off) or 6 levels (when the tail lights are on).

## Trip information

### ■ Driving range



Displays the estimated maximum distance that can be driven with the quantity of fuel remaining.

This distance is computed based on your average fuel consumption. As a result, the actual distance that can be driven may differ from that displayed.

### ■ Average fuel consumption after refueling

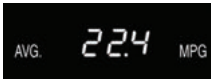

Displays the average fuel consumption since the vehicle was last refueled.

### ■ Current fuel consumption

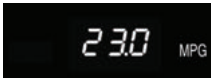

Displays the current rate of fuel consumption.

### ■ Average vehicle speed



Displays the average vehicle speed since the engine was started or the function was reset.

The function can be reset by pushing the "DISP" switch for longer than 1 second when the average vehicle speed is displayed.

**■ Barometer**

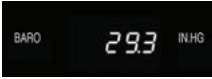

Displays the atmospheric pressure in the vehicle.

The displayed atmospheric pressure ranges from 17.8 IN.HG (600 hPa) up to 31.0 IN.HG (1050 hPa).

**■ Altimeter**



Displays the approximate altitude.

The displayed altitude ranges from -1500 ft. (-500 m) up to 13000 ft. (4000 m).

**■ Current fuel consumption**

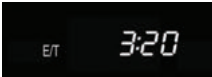

Displays the elapsed time after the engine starts.

When the engine is started, driving time is counted from 0:00. Up to 19:59 (19 hours, 59 minutes) can be displayed.

---

**■ Altimeter mode**

The indicated altitude of a single position may deviate according to the atmospheric pressure and temperature.

While the altitude mode is displayed, push the “▲” or “▼” button to increase/decrease the altitude by 50 ft. (or 10 m).

To reset the adjusted altitude, push and hold the “RESET” button for more than 1 second.

**▲ CAUTION**

**■ Caution while driving**

Do not adjust the display.

Doing so may cause the driver to mishandle the vehicle and an accident, resulting in death or serious injury.

## 2-3. Operating the lights and windshield wipers

### Headlight switch

The headlights can be operated manually or automatically.

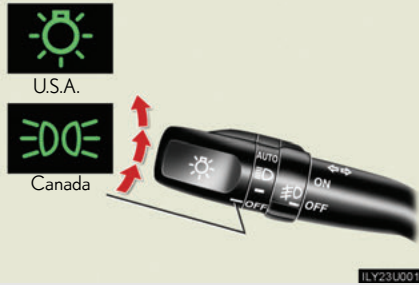

**—** The side marker, parking, tail, license plate and instrument panel lights turn on.

**≡** The headlights and all lights listed above turn on.

**AUTO** The headlights and all the lights listed above turn on and off automatically. (When the ignition switch is in the "ON" position.)

2

When driving

### Turning on the high beam headlights

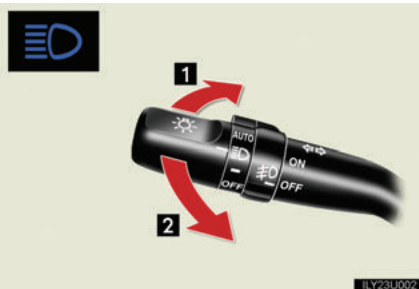

**1** With the headlights on, push the lever forward to turn on the high beams.

Pull the lever back to the center position to turn the high beams off.

**2** Pull the lever toward you to turn on the high beams.

Release to turn them off. You can flash the high beams with the headlights on or off.

### ■ Daytime running light system

To make your vehicle more visible to other drivers, the front turn signal lights turn on automatically whenever the engine is started and the parking brake is released.

### ■ Headlight control sensor





The sensor may not function properly if an object is placed on the sensor, or anything that blocks the sensor is affixed to the windshield.

Doing so interferes with the sensor detecting the level of ambient light and may cause the automatic headlight system to malfunction.

### ■ Automatic light off system

The headlights and tail lights turn off 30 seconds after a door is opened or closed if the ignition switch is turned to the “ACC” or “LOCK” position while the headlights are turned on. (The lights turn off immediately if the “LOCK” button on the key is pressed after all doors are locked.)

To turn the lights on again, turn the ignition switch to the “ON” position, or turn the light switch “OFF” once and then back to the  or  position.

### ■ Customization

Settings (e.g. light sensor sensitivity) can be changed. (→P. 400)

#### NOTICE

#### ■ To prevent battery discharge

Do not leave the lights on longer than necessary when the engine is not running.



## 2-3. Operating the lights and windshield wipers

### Fog light switch

The fog lights improve visibility in difficult driving conditions, such as in rain or fog. They can be turned on only when the headlights are on low beam.

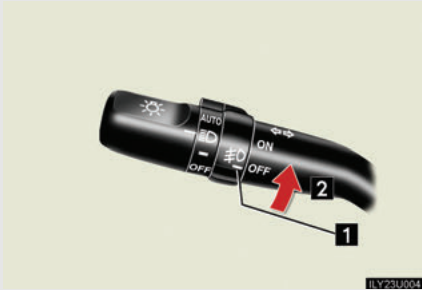

1 OFF

2 ON

## 2-3. Operating the lights and windshield wipers

### Windshield wipers and washer

#### ■ Intermittent wiper with interval adjuster (if equipped)

Wiper intervals can be adjusted for intermittent operation (when “INT” is selected).

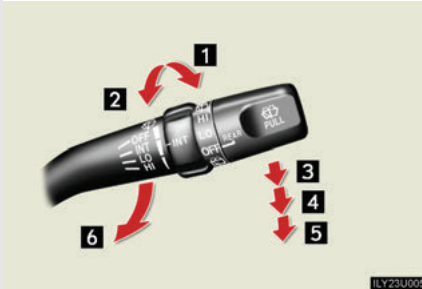

- 1 Intermittent wiper interval adjustment (increase)
- 2 Intermittent wiper interval adjustment (decrease)
- 3 Intermittent wiper operation
- 4 Low speed wiper operation
- 5 High speed wiper operation
- 6 Wash/wipe operation

#### ■ Rain-sensing windshield wipers (if equipped)

With “AUTO” selected, the wipers will operate automatically when the sensor detects falling rain. The system automatically adjusts wiper timing in accordance with rain volume and vehicle speed.

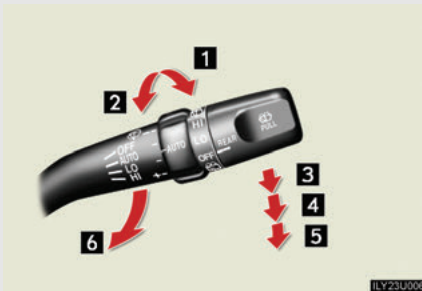

- 1 Sensor sensitivity (low)
- 2 Sensor sensitivity (high)
- 3 Rain-sensing wiper operation
- 4 Low speed wiper operation
- 5 High speed wiper operation
- 6 Wash/wipe operation

### ■ The windshield wiper and washer can be operated when

The ignition switch is in the “ON” position.

### ■ Dripping prevention wiper sweep

After washing and wiping operation several times, the wipers operate one more time after a short delay to prevent dripping.

However, the last sweep will not happen if the vehicle is traveling above 106 mph (170 km/h).

### ■ Effects of vehicle speed on wiper operation

Vehicle speed affects the following even when the wipers are not in “AUTO” mode.

- Intermittent wiper interval (“INT” mode)
- Wiper operation when the washer is being used (delay until drip prevention wiper sweep occurs)

With “LO” selected, wiper operation will be switched from low speed to intermittent wiper operation only when the vehicle is stationary.

### ■ Rain drop sensor (vehicles equipped with the rain-sensing windshield wipers)



The sensor judges the amount of raindrops.

### ■ If no windshield washer fluid sprays

Check that the washer nozzles are not blocked if there is washer fluid in the windshield washer fluid reservoir.

### ■ In extremely hot or cold weather

The system will turn off if the windshield gets extremely hot (more than 194°F [90°C]) or cold (less than 14°F [-10°C]).

### CAUTION

#### ■ Caution regarding the use of windshield wipers in "AUTO" mode

The windshield wipers may operate unexpectedly if the sensor is touched or the windshield is subject to vibration in "AUTO" mode. Take care that your fingers or anything else do not become caught in the windshield wipers.

### NOTICE

#### ■ When the windshield is dry

Do not use the wipers, as they may damage the windshield.

#### ■ When there is no washer fluid spray from the nozzle

Damage to the washer fluid pump may be caused if the lever is pulled toward you and held continually.

## 2-3. Operating the lights and windshield wipers

### Rear window wiper and washer

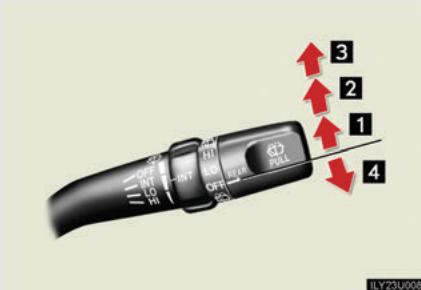

- 1 Intermittent window wiper operation.
- 2 Normal window wiper operation
- 3 Washer operation
- 4 Washer/wiper dual operation

2

When driving

- The rear window wiper and washer can be operated when  
The ignition switch must be in the "ON" position.

#### NOTICE

- **When the rear window is dry**  
Do not use the wipers, as they may damage the rear window.

## 2-4. Using other driving systems

# Cruise control

Use the cruise control to maintain a set speed without using the accelerator.

### ■ Set the vehicle speed



Turn the "ON-OFF" button ON.

Push the button once more to deactivate the cruise control.



Accelerate or decelerate to the desired speed and press the lever down to set the cruise control speed.

### ■ Adjusting the speed setting



1 Increase speed

2 Decrease speed

Hold the lever until the desired speed setting is obtained.

Fine adjustment of the set speed (approximately 1.0 mph [1.6 km/h]) can be made by lightly pressing the lever up or down and releasing it.

## ■ Canceling and resuming regular acceleration

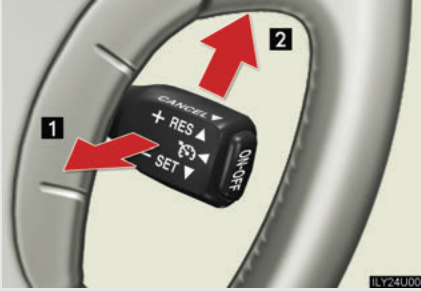

### 1 Cancel

Push the lever towards you to cancel cruise control.

The setting is also canceled when the brake pedal is depressed.

### 2 Resume

To resume cruise control and return to the set speed, push the lever up.

## ■ Cruise control can be set when

- The shift lever is in “D” or “4”.
- Vehicle speed is between approximately 25 mph (40 km/h) and 125 mph (200 km/h).

## ■ Accelerating

The vehicle can be accelerated normally. After acceleration, the set speed resumes.

## ■ Automatic cruise control cancelation

The set speed is automatically canceled in any of the following situations.

- Actual vehicle speed falls more than 10 mph (16 km/h) below the preset vehicle speed
- Actual vehicle speed is below 25 mph (40 km/h)
- VSC is activated

## ■ If the cruise control indicator light flashes

Turn the “ON-OFF” button off once, and then reactivate the system.

If the cruise control speed cannot be set or if the cruise control cancels immediately after being activated, there may be a malfunction in the cruise control system. Have the vehicle inspected by your Lexus dealer.

### CAUTION

#### ■ To avoid operating the cruise control by mistake

Keep the “ON-OFF” button off when not in use.

#### ■ Situations unsuitable for cruise control

Do not use cruise control in any of the following situations.

Doing so may result in control of the vehicle being lost and could cause a serious or fatal accident.

- In heavy traffic
- On roads with sharp bends
- On slippery roads, such as those covered with rain, ice or snow
- On steep hills
- On winding roads



## 2-4. Using other driving systems

### Four-wheel drive system

Use the four-wheel drive control lever and center differential lock button to select following transfer and center differential modes.

#### ► Four-wheel drive control lever



#### 1 "L" (low speed position)

Driving requiring maximum power and traction such as climbing or descending steep hills, off-road driving and hard pulling in sand or mud.

#### 2 "N" (neutral position)

No power is delivered to the wheels.

#### 3 "H" (high speed position)

Normal driving on all types of roads.

#### ► Center differential lock/unlock button



Use this button when your vehicle's wheel gets stuck in a ditch or when you are driving on a loose or bumpy surface.

#### ■ The four-wheel drive control lever can be operated when

- The ignition switch is in the "ON" position,
- The shift lever is in the "N" position, and
- The vehicle is stopped completely.

### ■ The center differential lock/unlock button can be operated when

- The ignition switch is in the “ON” position, and
- The four-wheel drive control lever is in the “H” or “L” position.

### ■ Locking/unlocking the center differential

- When the center differential is locked, VSC is automatically turned off. (The center differential lock and “VSC OFF” indicator lights come on.)
- If the operation is not completed, the center differential lock indicator blinks. If the indicator light does not go off when unlocking the center differential, drive straight ahead while accelerating or decelerating, or drive in reverse.
- If center differential lock system operation is not completed within 5 seconds while the cruise control system is set, cancel the cruise control system.

### CAUTION

#### ■ While driving

Never move the four-wheel drive control lever if the wheels are slipping. Doing so may cause an accident resulting in death or serious injury.

### NOTICE

#### ■ To prevent damage to the center differential

- Unlock the center differential after the wheels are out of the ditch or off the loose or bumpy surface.
- Do not push the center differential lock/unlock button when the vehicle is cornering or when its wheels are spinning freely off the ground.

## 2-4. Using other driving systems

# Rear height control air suspension

The rear height control air suspension adjusts the rear vehicle height in accordance with driving conditions. There are 3 selectable modes, “HI” (high), “N” (normal), and “LO” (low).

### ■ Height control switch



- 1 “▲” (Up) switch
- 2 “▼” (Down) switch
- 3 “OFF” switch

Push while the vehicle is stopped. The “OFF” indicator light will come on, and the vehicle height will be fixed in the current mode. Push the switch again to turn the system back on.

### ■ Height control indicator lights

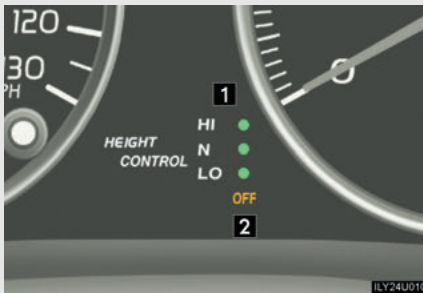

- 1 Height control mode indicators
- 2 Height control “OFF” indicator

## Vehicle height modes

Press “▲” to step up one mode, and “▼” to step down one mode. (e.g. When in the low mode, press “▲” once to switch to the normal mode, and twice to switch to the high mode.)

### ■ “HI” (high) mode

Rear vehicle height is 1.6 in. (40 mm) higher than the normal mode height.

This mode is suitable when driving on bumpy roads or through water.

High mode is only available when the vehicle speed is under 19 mph (30 km/h).

### ■ “N” (normal) mode

The standard vehicle height. This mode is suitable for ordinary driving.

### ■ “LO” (low) mode

Rear vehicle height is 0.8 in. (20 mm) lower than the normal mode height.

This mode allows easy access to the vehicle.

Low mode is only available when the vehicle speed is under 7 mph (12 km/h).

## Conditions for changing the vehicle height mode

Some modes may not be selectable depending on the vehicle speed. Refer to the following table.

	Low mode	Normal mode	High mode
Under 7 mph (12 km/h)	Yes	Yes	Yes
Under 19 mph (30 km/h)	No	Yes	Yes
19 mph (30 km/h) or over	No	Yes	No

## Height control indicator lights

If you change the vehicle height mode, the indicator lights change as follows:

- The current mode indicator light will turn off, and the selected mode indicator light will begin flashing.
- Once the change in vehicle height is complete, the selected mode indicator light will change from flashing to continuously lit.

2

When driving

### ■ Operating conditions

- The engine must be running.
- Vehicle speed must be within the acceptable range for the selected mode.

### ■ Automatic change in vehicle height

If the vehicle speed exceeds 19 mph (30 km/h) when in the high mode, or 7 mph (12 km/h) when in the low mode, normal mode is automatically selected.

### ■ Turning off the rear height control air suspension

- The system will remain off until the switch is pushed again, even if the ignition is turned off.
- Even if the rear height control air suspension is turned off, the system automatically selects the normal mode if the vehicle's speed exceeds 19 mph (30 km/h).

### ■ Automatic leveling function

The vehicle is adjusted to a fixed height for each mode, regardless of the number of occupants and the luggage load.

### ■ If the vehicle height does not change

If the area around the rear suspension is coated with ice, or the undercarriage has come into contact with the road surface, the rear height control suspension will not operate. In this case, the indicator lights will change as follows:

- The current mode indicator light will turn off, and the target mode indicator light will begin flashing.
- The target mode indicator light will turn off, and the original mode indicator light will be lit once more. (The vehicle height does not change.)

If the rear height control air suspension cannot be operated even after removing the ice or progressing to a smooth driving surface, turn off and restart the engine.

### ■ Parking and stopping tips

- If you immediately stop the engine after off-road driving, or park the vehicle for a long time, the vehicle height may gradually lower. When parking, make sure there is nothing under the vehicle that may come in contact with the underbody. The vehicle will return to the set height when the engine is started.
- The vehicle height may change as the temperature changes when the engine is stopped. The vehicle will return to the set height when the engine is started.

### ■ When lowering the vehicle

Even if the engine is stopped while the vehicle height is being lowered, operation will continue for up to 25 seconds. If any of the side doors or the back door is opened within this 25 seconds, operation will continue for a further 15 seconds.

### ■ Rear height control failure warning

- If a malfunction occurs in the rear height control air suspension, normal mode is automatically selected.  
The height control “OFF” indicator will blink, and the vehicle height control cannot be activated until the malfunction is corrected. Have the vehicle checked at your Lexus dealer as soon as possible.
- If the height control “OFF” indicator light does not come on when the ignition switch is turned to the “ON” position, there is a malfunction in the rear height control air suspension. You can continue normal driving, however have the vehicle checked by your Lexus dealer as soon as possible.

 **CAUTION**

Failure to observe the following precautions may result in an accident.

■ **Using the high mode**

This modes should only be used for rough off-road conditions. Because the vehicle's center of gravity is higher when in the high mode, the vehicle may become unstable when turning abruptly.

■ **When jacking up the vehicle or installing tire chains**

Turn off the rear height control air suspension and stop the engine, otherwise the vehicle height may change due to the automatic leveling function.

■ **When driving through water deeper than 2.3 ft. (0.7 m)**

Select the "HI" (high) mode and turn off rear height control air suspension. Drive at 19 mph (30 km/h) or lower. Otherwise, the vehicle height may change due to the automatic leveling function.

■ **If your vehicle must be towed**

Put the vehicle height in the normal mode and turn off the rear height control air suspension, otherwise the vehicle height may change due to the automatic leveling function.

■ **If your vehicle becomes stuck in a ditch**

Turn off the rear height control air suspension, otherwise the vehicle height may change due to the automatic leveling function.

### NOTICE

#### ■ **To avoid damage to the vehicle**

- If in the low mode, the vehicle automatically shifts to the normal mode (vehicle height is raised) when the engine is started. Take care when overhead height is limited.
- After unloading, the vehicle height may be slightly higher than normal. Take care when overhead height is limited.
- Before lowering the vehicle height, check that no-one is under the vehicle and the area is free of obstructions. Also check that the underbody of the vehicle will not touch the ground.
- Do not select the low mode when driving on bumpy roads, as the underbody of the vehicle may contact the road surface.

#### ■ **Avoid rapid changes to the vehicle height when the vehicle is heavily loaded**

As the compressor may overheat, causing the vehicle height adjustment operation to stop.



## 2-4. Using other driving systems

# Electronic modulated suspension

The electronic modulated suspension controls the suspension according to the road and driving conditions. Selected driving mode allows for good riding comfort and stability.

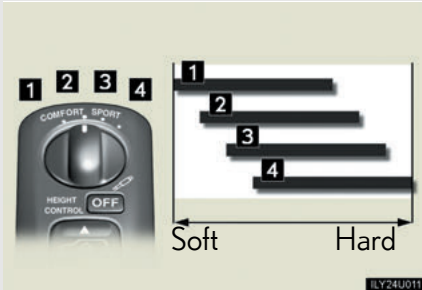

- 1 For driving on a bumpy road
- 2 For ordinary driving such as in the city traffic
- 3 For moderate high speed driving
- 4 For sporty type driving such as on winding mountain roads and high speed driving.

### ■ Driving mode

- Mode **1** is suitable for ordinary driving.
- Mode **3** or **4** is suitable for heavy load or driving on a unpaved road.
- With the four-wheel drive control lever at "L", the damping effect suitable for off-road driving will be provided.

## 2-4. Using other driving systems

# DAC (Downhill Assist Control system)

The DAC system helps to prevent excessive speed on steep downhill slopes.

The system will operate when the vehicle is traveling under 15 mph (25km/h) and the four wheel drive control lever is in the “L” position.

### ■ System operation



Press the “DAC” switch. The indicator will come on, and the system will operate.

When the system is in operation, the slip indicator light will flash, and the stop lights/high mounted stop lights will be lit.

### ■ Turning off the system

Press the “DAC” switch while the system is in operation. The indicator will flash as the system gradually ceases operation, and will turn off when the system is fully off.

Press the “DAC” switch while the indicator is flashing to start the system again.

### ■ Operating tips

The system will operate when the shift lever is in a position other than "P", however to make effective use of the system it is recommended that the shift lever be shifted to "2" or "L".

### ■ If the four wheel drive control lever is in "H"

The system will not operate.

### ■ If the brake system overheats

The system will cease operation and a buzzer will sound to alert the driver. Stop the vehicle in a safe place. (There is no problem with continuing normal driving.)

### ■ System malfunction

- The "DAC" indicator does not come on when the ignition key is turned to the "ON" position.
- The "DAC" indicator does not come on when the "DAC" switch is pressed.

In the above cases have your vehicle checked by your Lexus dealer.

### CAUTION

■ The system may not operate on the following surfaces, which may lead to an accident causing death or serious injury.

- Slippery surfaces such as wet or muddy roads
- Icy surfaces
- Unpaved roads

## 2-4. Using other driving systems

### Driving assist systems

To help enhance driving safety and performance, the following systems operate automatically in response to various driving situations. Be aware, however, that these systems are supplementary and should not be relied upon too heavily when operating the vehicle.

#### ■ ABS (Anti-lock Brake System)

Restrains the vehicle from slipping when driving on slick road surfaces or in the event of sudden braking.

#### ■ BA (Brake Assist)

Generates an increased level of braking force after the brake pedal is depressed, when the system detects a panic stop situation.

#### ■ VSC (Vehicle Stability Control)

Helps the driver to control skidding when swerving suddenly or turning on slippery road surfaces.

#### ■ Active traction control

Maintains drive power and prevents the 4 wheels from spinning when starting the vehicle or accelerating on slippery roads.

#### ■ Hill-start assist control

Helps prevent the vehicle from rolling backwards when starting on an incline or slippery slope. It operates for approximately 5 seconds at maximum.

#### ■ LSD (Limited Slip Differential)

Transfers drive power to the rear tires when front tires spin, and vice versa, in order to improve traction.

#### ■ KDSS (Kinetic Dynamic Suspension System) (if equipped)

KDSS helps to significantly enhance handling response by reducing roll stiffness of the suspension stabilizer bars through means of a hydraulic control system.

## When the VSC/TRAC/hill-start assist control systems are operating

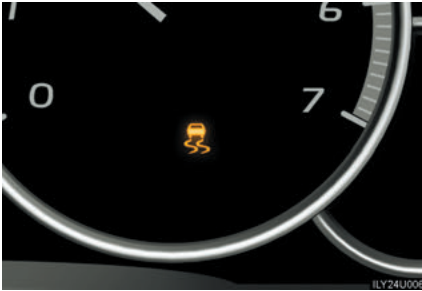

If the vehicle is in danger of slipping, rolling backwards when starting on an incline, or if the rear wheels spin, the slip indicator light flashes to indicate that the VSC/TRAC/hill-start assist control systems have been engaged.

A buzzer (intermittent) sounds to indicate that VSC is operating.

The stop lights and high mounted stoplight turn on when the hill-start assist control system is operating.

The slip indicator light flashes as well when ABS is operating.

2

When driving

### ■ Sounds and vibrations caused by the ABS, BA, VSC, TRAC and hill-start assist control systems

- A sound may be heard from the engine compartment when the engine is started or just after the vehicle begins to move. This sound does not indicate that a malfunction has occurred in any of these systems.
- Any of the following conditions may occur when the above systems are operating. None of these indicates that a malfunction has occurred.
  - Vibrations may be felt through the vehicle body and steering.
  - A motor sound may be heard after the vehicle comes to a stop.
  - The brake pedal may pulsate slightly after the ABS is activated.
  - The brake pedal may move down slightly after the ABS is activated.

### ■ Hill-start assist control is operational when

- The shift lever is in any of the positions "D", "4", "3", "2" or "L".
- The brake pedal is not depressed.

### CAUTION

Any of the following conditions may result in an accident which could cause death or serious injury:

#### ■ **The ABS does not operate effectively when**

- The limits of tire gripping performance have been exceeded.
- The vehicle hydroplanes while driving at high speed on the wet or slick road.

#### ■ **Stopping distance when the ABS is operating on the wet or slick roads**

The ABS is not designed to shorten the vehicle's stopping distance. Always maintain a safe distance from the vehicle in front of you in the following situations.

- When driving on dirt, gravel or snow-covered roads
- When driving with tire chains
- When driving over bumps in the road
- When driving over roads with potholes or roads with uneven roads

#### ■ **TRAC may not operate effectively when**

Directional control and power may not be achievable while driving on slippery road surfaces, even if the TRAC is operating.

Do not drive the vehicle in conditions where stability and power may be lost.

#### ■ **The hill-start assist control may not operate effectively when**

- On steep inclines.
- On icy surfaces.

#### ■ **When the VSC is activated**

The slip indicator light flashes and a warning buzzer sounds. Always drive carefully. Reckless driving may cause an accident. Exercise particular care when the indicator light flashes and a buzzer sounds.

#### ■ **Replacing tires**

Make sure that all tires are of the same size, brand, tread pattern and total load capacity. In addition, make sure that the tires are inflated to the specified tire pressure level.

The ABS and VSC will not function correctly if different tires are fitted on the vehicle.

Contact your Lexus dealer for further information when replacing tires or wheels.

## 2-5. Driving information

### Off-road precautions

This vehicle belongs to the utility vehicle class, which has higher ground clearance and narrower tread in relation to the height of its center of gravity to make it capable of performing in a wide variety of off-road applications.

#### Off-road vehicle feature

- Specific design characteristics give it a higher center of gravity than ordinary passenger cars. This vehicle design feature causes this type of vehicle to be more likely to rollover. And, utility vehicles have a significantly higher rollover rate than other types of vehicles.
- An advantage of the higher ground clearance is a better view of the road allowing you to anticipate problems.
- It is not designed for cornering at the same speeds as ordinary passenger cars any more than low-slung sports cars designed to perform satisfactorily under off-road conditions. Therefore, sharp turns at excessive speeds may cause rollover.

### CAUTION

#### ■ Off-road vehicle precautions

Always observe the following precautions to minimize the risk of serious personal injury or damage to your vehicle:

- In a rollover crash, an unbelted person is significantly more likely to die than a person wearing a seat belt. Therefore, the driver and all passengers should fasten their seat belts whenever the vehicle is moving.
- Avoid sharp turns or abrupt maneuvers, if at all possible.  
Failure to operate this vehicle correctly may result in loss of control or vehicle roll-over causing death or serious injury.
- Loading cargo on the roof luggage carrier will make the center of the vehicle gravity higher. Avoid high speeds, sudden starts, sharp turns, sudden braking or abrupt maneuvers, otherwise it may result in loss of control or vehicle rollover due to failure to operate this vehicle correctly.
- Always slow down in gusty crosswinds. Because of its profile and higher center of gravity, your vehicle is more sensitive to side winds than an ordinary passenger car. Slowing down will allow you to have better control.
- Do not drive horizontally across steep slopes. Driving straight up or straight down is preferred. Your vehicle (or any similar off-road vehicle) can tip over sideways much more easily than forward or backward.



## Off-road driving

When driving your vehicle off-road, please observe the following precautions to ensure your driving enjoyment and to help prevent the closure of areas to off-road vehicles.

- Drive your vehicle only in areas where off-road vehicles are permitted to travel.
- Respect private property. Get owner's permission before entering private property.
- Do not enter areas that are closed. Honor gates, barriers and signs that restrict travel.
- Stay on established roads. When conditions are wet, driving techniques should be changed or travel delayed to prevent damage to roads.

---

### ■ Additional information for off-road driving

► For owners in U.S. mainland, Hawaii and Puerto Rico:

To obtain additional information pertaining to driving your vehicle off-road, consult the following organizations.

- State and Local Parks and Recreation Departments
- State Motor Vehicle Bureau
- Recreational Vehicle Clubs
- U.S. Forest Service and Bureau of Land Management

### CAUTION

#### ■ Off-road driving precautions

Always observe the following precautions to minimize the risk of serious personal injury or damage to your vehicle:

- Drive carefully when off the road. Do not take unnecessary risks by driving in dangerous places.
- Do not grip the steering wheel spokes when driving off-road. A bad bump could jerk the wheel and injure your hands. Keep both hands and especially your thumbs on the outside of the rim.
- Always check your brakes for effectiveness immediately after driving in sand, mud, water or snow.
- After driving through tall grass, mud, rock, sand, rivers, etc., check that there is no grass, bush, paper, rags, stone, sand, etc. adhering or trapped on the underbody. Clear off any such matter from the underbody. If the vehicle is used with these materials trapped or adhering to the underbody, a breakdown or fire could occur.
- When driving off-road or in rugged terrain, do not drive at excessive speeds, jump, make sharp turns, strike objects, etc. This may cause loss of control or vehicle rollover causing death or serious injury. You are also risking expensive damage to your vehicle's suspension and chassis.

### NOTICE

#### ■ To prevent the water damage

Take all necessary safety measures to ensure that water damage to the engine or other components does not occur.

- Water entering the engine air intake will cause severe engine damage.
- Water entering the automatic transmission will cause deterioration in shift quality, locking up of your transmission accompanied by vibration, and ultimately damage.
- Water can wash the grease from wheel bearings, causing rusting and premature failure, and may also enter the differentials, transmission and transfer case, reducing the gear oil's lubricating qualities.

 NOTICE**■ When you drive through water**

If driving through water, such as when crossing shallow streams, first check the depth of the water and the bottom of the river bed for firmness. Drive slowly and avoid deep water.

**■ Inspection after off-road driving**

- Sand and mud that has accumulated in brake drums and around brake discs may affect braking efficiency and may damage brake system components.
- Always perform a maintenance inspection after each day of off-road driving that has taken you through rough terrain, sand, mud, or water. For scheduled maintenance information, refer to the “Warranty and Services Guide/Owner’s Manual Supplement/Scheduled Maintenance”.

## 2-5. Driving information

# Cargo and luggage

Take notice of the following information about storage precautions, cargo capacity and load.

- Stow cargo and luggage in the luggage compartment whenever possible. Be sure all items are secured in place.
- Be careful to keep the vehicle level. Placing the weight as far forward as possible helps maintain vehicle balance.
- For better fuel economy, do not carry unnecessary weight.

### Capacity and distribution

Cargo capacity depends on the total weight of the occupants.

(Cargo capacity) = (Total load capacity) – (Total weight of occupants)

#### Steps for Determining Correct Load Limit—

- (1) Locate the statement “The combined weight of occupants and cargo should never exceed XXX kg or XXX lbs.” on your vehicle’s placard.
- (2) Determine the combined weight of the driver and passengers that will be riding in your vehicle.
- (3) Subtract the combined weight of the driver and passengers from XXX kg or XXX lbs.
- (4) The resulting figure equals the available amount of cargo and luggage load capacity.

For example, if the “XXX” amount equals 1400 lbs. and there will be five 150 lb passengers in your vehicle, the amount of available cargo and luggage load capacity is 650 lbs. (1400 - 750 (5 × 150) = 650 lbs.)

- (5) Determine the combined weight of luggage and cargo being loaded on the vehicle.

That weight may not safely exceed the available cargo and luggage load capacity calculated in Step 4.

- (6) If your vehicle will be towing a trailer, load from your trailer will be transferred to your vehicle. Consult this manual to determine how this reduces the available cargo and luggage load capacity of your vehicle. (→P. 144)

### Example on your vehicle

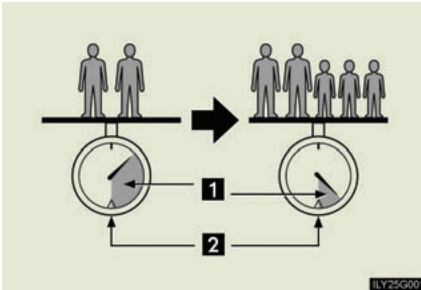

- 1 Cargo capacity  
2 Total load capacity

When 2 people with the combined weight of 366 lb. (166 kg) are riding in your vehicle, the available amount of cargo and luggage load capacity will be as follows:

- With third seats – total load capacity: 1200 lb. (544 kg)  
1200 lb. - 366 lb. = 834 lb. (544 kg - 166 kg = 378 kg)
- Without third seats – total load capacity: 1000 lb. (454 kg)  
1000 lb. - 366 lb. = 634 lb. (454 kg - 166 kg = 288 kg)

From this condition, if 3 more passengers with the combined weight of 388 lb. (176 kg) get on, the available cargo and luggage load will be reduced as follows:

- With third seats  
834 lb. - 388 lb. = 446 lb. (378 kg - 176 kg = 202 kg)
- Without third seats  
634 lb. - 388 lb. = 246 lb. (288 kg - 176 kg = 112 kg)

As shown in the above example, if the number of occupants increases, the cargo and luggage load equaling the combined weight of the occupants who got on later, by an amount. In other words, if an increase in the number of occupants causes an excess of the total load capacity (combined weight of occupants plus cargo and luggage load), you must reduce the cargo and luggage on your vehicle.

### Seating configuration variation

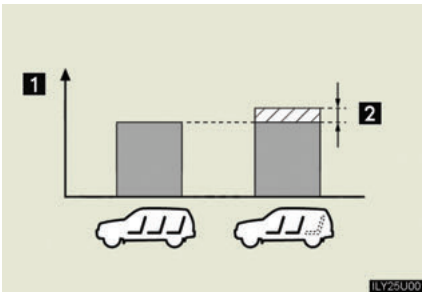

1 Cargo capacity

2 Weight of removed third seat

If removing the third seat, it is possible to load extra cargo equal to the weight of the removed seats.

(Cargo capacity) = (Total load capacity) - (Total weight of occupants) + (Weight of the removed third seats)

Third seat weight:

Right side – 30.2 lb. (13.7 kg)

Left side – 32.4 lb. (14.7 kg)

 **CAUTION****■ Storage precautions**

- Do not place anything on the luggage cover, and do not stack anything in the luggage compartment higher than the seatbacks. Such items may be thrown about and possibly injure people in the vehicle during sudden braking or in an accident.
- Do not drive with objects on top of the instrument panel. They may interfere with the driver's field of view or move during sharp acceleration or turning, thus impairing the driver's control of the vehicle. In an accident they may injure the vehicle occupants.
- Secure all items in the occupant compartment, as they may shift and injure someone during an accident or sudden braking.
- Never allow anyone to ride in the luggage compartment. It is not designed for passengers. They should ride in their seats with their seat belts properly fastened. Otherwise, they are much more likely to suffer serious bodily injury, in the event of sudden braking or a collision.

**■ Weight of the load**

- Improper loading may cause deterioration of steering or braking control resulting in an accident which may cause death or serious injury.
- Do not exceed the maximum axle weight rating or the total vehicle weight rating.
- Even if the total load of occupant's weight and the cargo load is less than the total load capacity, do not apply the load unevenly. Improper loading may cause deterioration of steering or braking control which may cause death or serious injury.

### Vehicle load limits

Vehicle load limits include total load capacity, seating capacity, towing capacity and cargo capacity.

■ **Total load capacity:**

With third seats – 1200 lb. (544 kg)

Without third seats – 1000 lb. (454 kg)

Total load capacity means the combined weight of occupants, cargo and luggage.

■ **Seating capacity:**

With third seats – Total 8 (Front 2, Rear 6)

Without third seats – Total 5 (Front 2, Rear 3)

Seating capacity means the maximum number of occupants whose estimated average weight is 150 lb. (68 kg) per person.

Even if the number of occupants are within the seating capacity, do not exceed the total load capacity.

■ **Towing capacity: 6500 lb. (2948 kg)**

Towing capacity means the maximum gross trailer weight (trailer weight plus its cargo weight) that your vehicle is able to tow.

■ **Cargo capacity**

Cargo capacity may increase or decrease depending on the weight and the number of occupants.



---

**■ Total load capacity and seating capacity**

These details are also described on the tire and loading information label.  
(→P. 309)

** CAUTION****■ Overloading the vehicle**

Do not overload the vehicle.

It may not only cause damage to the tires, but also degrade steering and braking ability, resulting in an accident.

# Winter driving tips

Carry out the necessary preparations and inspections before driving the vehicle in winter. Always drive the vehicle in a manner appropriate to the prevailing weather conditions.

### ■ Pre-winter preparations

- Use fluids that are appropriate to the prevailing outside temperatures.
  - Engine oil
  - Engine coolant
  - Washer fluid
- Have a service technician inspect the level and specific gravity of battery electrolyte.
- Have the vehicle fitted with four snow tires or purchase a set of tire chains for the rear tires.

Ensure that all tires are the same size and brand, and that chains match the size of the tires.

### ■ Before driving the vehicle

Perform the following according to the driving conditions.

- Do not try to forcibly open a window or move a wiper that is frozen. Pour warm water over the frozen area to melt the ice. Wipe away the water immediately to prevent it from freezing.
- To ensure proper operation of the climate control system fan, remove any snow that has accumulated on the air inlet vents in front of the windshield.
- Remove any ice that has accumulated on the vehicle chassis.
- Periodically check for and remove any excess ice or snow that may have accumulated in the wheel well or on the brakes.

### ■ When driving the vehicle

Accelerate the vehicle slowly and drive at a reduced speed suitable to road conditions.

### ■ When parking the vehicle

Park the vehicle and move the shift lever to “P” without setting the parking brake. The parking brake may freeze, preventing it from being released.

2

## Selecting snow chains

Use the correct snow chain size when mounting the snow chains. Chain size is regulated for each tire sizes.

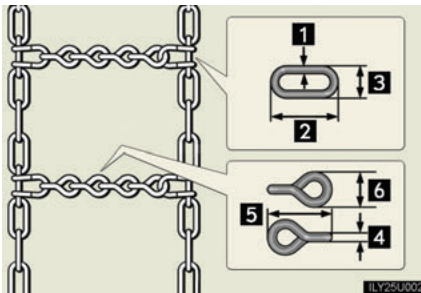

Side chain:

- 1 0.20 in. (5.0 mm)
- 2 1.81 in. (46.0 mm)
- 3 0.71 in. (18.0 mm)

Cross chain:

- 4 0.25 in. (6.3 mm)
- 5 1.5 in. (38.1 mm)
- 6 0.89 in. (22.6 mm)

When driving

## Regulations on the use of snow chains

- Regulations regarding the use of tire chains vary according to location and type of road. Always check local regulations before installing chains.
- Install the chains on the rear tires.
- Retighten the chains after driving 1/4 - 1/2 mile (0.5 - 1.0 km).

### ■ Snow chain installation

Observe the following precautions when installing and removing chains.

- Install and remove tire chains in a safe location.
- Install tire chains on the rear tires.
- Install tire chains in accordance with the accompanying instructions.

### CAUTION

#### ■ Driving with snow tires

Observe the following precautions to reduce the risk of accidents.

Failing to do so may result in a loss of vehicle control and cause death or serious injury.

- Use tires of the size specified for your vehicle.
- Maintain the specified level of tire inflation pressure.
- Do not drive in excess of 65 mph (105 km/h), regardless of the type of snow tires being used.
- Snow tires should be installed on all wheels.

#### ■ Driving with snow chains

Observe the following precautions to reduce the risk of accidents.

Failing to do so may result in the vehicle being unable to be driven safely, and may cause death or serious injury.

- Do not drive in excess of the speed limit specified for the tire chains being used, or 30 mph (50 km/h), whichever is lower.
- Avoid driving on bumpy road surfaces or over potholes.
- Avoid sudden turns and braking, as use of chains may adversely affect vehicle handling.
- Slow down sufficiently before entering a curve to ensure that vehicle control is maintained.

 NOTICE**■ Repairing or replacing snow tires**

Request repairs of and obtain replacement snow tires from Lexus dealer.

This is because the removal and attachment of snow tires affects the operation of the tire pressure warning valves and transmitters.

**■ When jacking up or installing tire chains**

Be sure to turn off the rear height control air suspension and stop the engine.

Otherwise, the vehicle height may change because of the automatic leveling function, resulting in an accident.

**■ Fitting tire chains**

The tire pressure warning valves and transmitters may not function correctly when tire chains are fitted.

## 2-5. Driving information

# Trailer towing

Your vehicle is designed primarily as a passenger-and-load carrying vehicle. Towing a trailer will have an adverse effect on handling, performance, braking, durability, and fuel consumption. For your safety and the safety of others, do not overload the vehicle or trailer.

Lexus warranties do not apply to damage or malfunction caused by towing a trailer for commercial purposes.

### ■ Weight limits

Confirm that the total trailer weight, gross vehicle weight, gross axle weight and trailer tongue load are all within the limits.

### ■ Gross vehicle weight

The gross vehicle weight must not exceed the Gross Vehicle Weight Rating (GVWR) indicated on the Certification Label. The gross vehicle weight is the sum weight of the unloaded vehicle, driver, passengers, luggage, hitch and trailer tongue load. Also included is the weight of any special equipment installed on your vehicle.

### ■ Gross axle weight

The load on either the front or rear axle resulting from distribution of the gross vehicle weight on both axles must not exceed the Gross Axle Weight Rating (GAWR) listed on the Certification Label.

### ▶ Certification Label



### ■ Trailer tongue load

The trailer cargo load should be distributed so that the tongue load is 9 to 11% for weight carrying hitch or 15% for weight distributing hitch of the total trailer weight, not exceeding the following.

Weight carrying hitch: 650 lb. (294 kg)

Weight distributing hitch: 975 lb. (442 kg)

(Tongue load/Total trailer weight x 100 = 9 to 11% or 15%)

The total trailer weight and tongue load can be measured with platform scales found at a highway weighing stations, building supply companies, trucking companies, junk yards, etc.

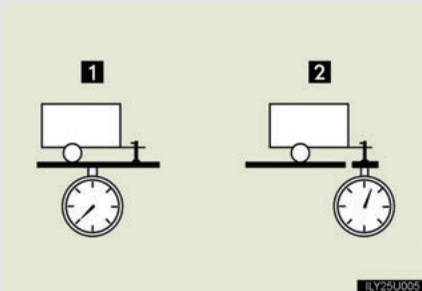

1 Total trailer weight

2 Tongue load

### Towing a trailer

Contact your Lexus dealer for further information about additional requirements such as a towing kits, etc.

### Hitch and tow hitch receiver

#### ■ Hitch

Trailer hitch assemblies have different weight capacities established by the hitch manufacturer. Even though the vehicle may be rated for towing a higher weight, the operator must never exceed the maximum weight rating specified for the trailer hitch.

### ■ Tow hitch receiver



A tow hitch receiver installed under the rear bumper is rated for weight that does not exceed the vehicle's total towing weight.

### Selecting trailer ball

Use the correct trailer ball for your application.

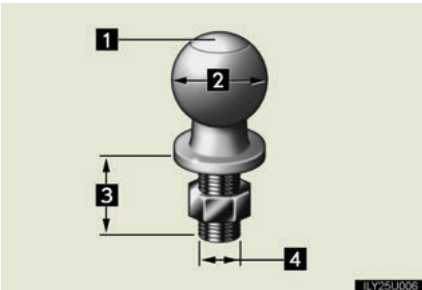

#### 1 Trailer ball load rating

Matches or exceeds the gross trailer weight rating of the trailer.

#### 2 Ball diameter

Matches the size of the trailer coupler. Most couplers are stamped with the required trailer ball size.

#### 3 Shank length

Protrudes beyond the bottom of the lock washer and nut at least 2 threads.

#### 4 Shank diameter

Matches the ball mount hole diameter size.



## Connecting trailer lights

Use the wire harness stored in the rear end underbody.

### ■ When connecting and disconnecting a trailer

#### ▶ Connecting

- STEP 1** Set the rear height control air suspension to “LO” mode.
- STEP 2** Turn off the ignition switch or the rear height control air suspension.
- STEP 3** Connect the trailer.
- STEP 4** Turn on the switch that was turned off on STEP 2.
- STEP 5** Set the rear height control air suspension to “N” mode.

#### ▶ Disconnecting

- STEP 1** Set the rear height control air suspension to “LO” mode.
- STEP 2** Turn off the ignition switch or the rear height control air suspension.
- STEP 3** Set the supporting leg of the trailer on the ground and raise the hitch by 4 in. (100 mm).
- STEP 4** Turn on the switch that was turned off on STEP 2.
- STEP 5** Wait until vehicle height is stabilized.
- STEP 6** Make sure the hitch is disconnected. If the hitch does not disconnect, raise the hitch higher and repeat steps 2 through 5.
- STEP 7** Move the vehicle forward in the “LO” mode where the hitch does not touch anything in the “N” mode.
- STEP 8** Set the rear height control air suspension in the “N” mode.

### ■ Before towing

Check that the following conditions are met:

- The vehicle's tires are properly inflated. (→P. 385)
- Trailer tires are inflated according to the trailer manufacturer's recommendation.
- All trailer lights work.
- All lights work each time you connect them.
- The trailer ball is set up at the proper height for the coupler on the trailer.
- The vehicle remains level when a loaded or unloaded trailer is hitched. Do not drive if the vehicle is not level, and check for improper tongue load, overloading, worn suspension, or other possible causes.
- The trailer cargo is securely loaded.
- The rear view mirrors conform to all applicable federal, state/provincial or local regulations. If they do not, install rear view mirrors appropriate for towing purposes.

### ■ Break-in schedule

Lexus recommends that you do not use a new vehicle or a vehicle with any new power train components (engine, transmission, differential, wheel bearings, etc.) to tow a trailer for the first 500 miles (800 km) of driving.

### ■ Maintenance

- If you tow a trailer, your vehicle will require more frequent maintenance due to the additional load. (See "Warranty and Services Guide/Owner's Manual Supplement/Scheduled Maintenance".)
- Retighten the fixing bolts of the towing ball and bracket after approximately 600 miles (1000 km) of trailer towing.

 **CAUTION****■ To avoid accident or injury**

- The total trailer weight (trailer weight plus the weight of cargo) must not exceed 6500 lb. (2948 kg).
- If a trailer and cargo weight over 2000 lb. (907 kg), use a sway control device with sufficient capacity.
- The gross combined weight (sum of your vehicle weight plus its load and the total trailer weight) must not exceed 12000 lb. (5443 kg).
- Do not exceed the trailer hitch assembly weight, gross vehicle weight, gross axle weight and trailer tongue load capacities.
- Never load more weight in the back than in the front of the trailer. About 60% of the load should be in the front half of the trailer, and the remaining 40% in the rear.
- Set the vehicle height to the “LO” mode and turn off the rear height control air suspension to prevent the vehicle height from automatically changing.
- The tow hitch receiver installed on your vehicle must never be used on another vehicle

**■ Hitches**

- If you wish to install a trailer hitch, contact your Lexus dealer.
- Use only a hitch that conforms to the total trailer weight requirement.
- Follow the directions supplied by the hitch manufacturer.
- Lubricate the hitch ball with a light coat of grease.
- Remove the trailer hitch whenever you are not towing a trailer. After removing the hitch, seal any mounting hole in the vehicle body to prevent entry of any substances into the vehicle.

**■ When towing a trailer**

- If the total trailer weight exceeds 1000 lb. (453 kg), trailer brakes are required.
- Never tap into your vehicle’s hydraulic system, as this will lower the vehicle’s braking effectiveness.
- Never tow a trailer without using a safety chain securely attached to both the trailer and the vehicle. If damage occurs to the coupling unit or hitch ball, there is danger of the trailer wandering into another lane.

### NOTICE

#### ■ **When installing a trailer hitch**

- Use only the position recommended by your Lexus dealer. Do not install the trailer hitch on the bumper; this may cause body damage.
- Do not use axle-mounted hitches, as they can cause damage to the axle housing, wheel bearings, wheels or tires.

#### ■ **Brakes**

Lexus recommends trailers with brakes that conform to all applicable federal and state/provincial regulations.

#### ■ **Safety chain**

A safety chain must always be used between the towing vehicle and the trailer. Leave sufficient slack in the chain for turns. The chain should cross under the trailer tongue to prevent the tongue from dropping to the ground in the case that it becomes damaged or separated. For the correct safety chain installation procedure, ask your Lexus dealer.

#### ■ **Do not directly splice trailer lights**

Directly splicing trailer lights may damage your vehicle's electrical system and cause a malfunction.

## Trailer towing tips

Your vehicle will handle differently when towing a trailer. The 3 main causes of vehicle-trailer accidents are driver error, excessive speed and improper trailer loading. Keep the following in mind when towing.

- Before starting out, check the trailer lights and the vehicle-trailer connections. Recheck after driving a short distance.
- Practice turning, stopping and reversing with the trailer attached in an area away from traffic until you become accustomed to the feel of the vehicle.
- Reversing with a trailer attached is difficult and requires practice Grip the bottom of the steering wheel and move your hand to the left to move the trailer to the left. Move your hand to the right to move the trailer to right. (This is generally opposite to reversing without a trailer attached.) Avoid sharp or prolonged turning. Have someone guide you when reversing to reduce the risk of an accident.
- As stopping distance is increased when towing a trailer, vehicle-to-vehicle distance should be increased. For each 10 mph (16 km/h) of speed, allow at least one vehicle and trailer length.
- Avoid sudden braking as you may skid, resulting in jackknifing and loss of control. This is especially true on wet or slippery surfaces.
- Avoid jerky starts or sudden acceleration.
- Avoid jerky steering and sharp turns, and slow down before making turns.

- Note that when making a turn, the trailer wheels will be closer than the vehicle wheels to the inside of the turn. Compensate by making a larger than normal turning radius.
- Crosswinds and rough roads will adversely affect handling of your vehicle and trailer, causing sway. Periodically check the rear to prepare for being passed by large trucks or buses, which may cause your vehicle and trailer to sway. If swaying occurs, firmly grip the steering wheel, reduce speed immediately but gradually, and steer straight ahead. Never increase speed. If you make no extreme correction with the steering or brakes, your vehicle and trailer will stabilize.
- Take care when passing other vehicles. Passing requires considerable distance. After passing a vehicle, do not forget the length of your trailer, and be sure you have plenty of room before changing lanes.
- In order to maintain efficient engine braking and electrical charging performance, do not use overdrive. Transmission shift range position must be in "4".
- Due to the added load of the trailer, your vehicle's engine may overheat on hot days (at temperatures over 85°F [30°C] when driving up a long or steep grade. If the engine coolant temperature gauge indicates overheating, immediately turn off the air conditioning (if in use), pull your vehicle off the road and stop in a safe spot. (→P. 373)

- Always place wheel blocks under both the vehicle and the trailer wheels when parking. Apply the parking brake firmly, and put the transmission in “P”. Avoid parking on a slope, but if unavoidable, do so only after performing the following:

**STEP 1** Apply the brakes and keep them applied.

**STEP 2** Have someone place wheel blocks under both the vehicle and trailer wheels.

**STEP 3** When the wheel blocks are in place, release the brakes slowly until the blocks absorb the load.

**STEP 4** Apply the parking brake firmly.

**STEP 5** Shift into “P” and turn off the engine.

- When restarting after parking on a slope:

**STEP 1** With the transmission in the “P” position, start the engine. Be sure to keep the brake pedal pressed.

**STEP 2** Shift into “3”, “2”, “L”, or “R” position (if reversing).

**STEP 3** Release the parking brake and brake pedal, and slowly pull or back away from the wheel blocks. Stop and apply the brakes.

**STEP 4** Have someone retrieve the blocks.

### CAUTION

#### ■ To avoid an accident

- Do not exceed 45 mph (72 km/h) or the posted towing speed limit, whichever is lower. A instability (swaying) of the towing vehicle-trailer combination increases as speed increases, exceeding 45 mph (72 km/h) may cause loss of control.
- Slow down and downshift before descending steep or long downhill grades. Do not make sudden downshifts.
- Avoid holding the brake pedal down too long or applying the brakes too frequently.

This could cause the brakes to overheat and result in reduced braking efficiency.

## 2-5. Driving information

### Dinghy towing

Your vehicle is not designed to be dinghy towed (with 4 wheels on the ground) behind a motor home.

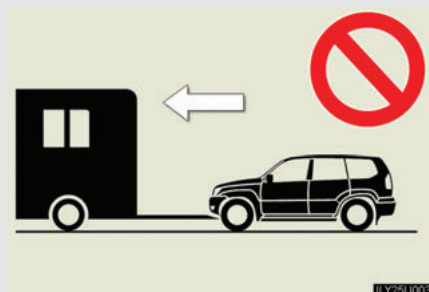

#### NOTICE

■ **To avoid serious damage to your vehicle**

Do not tow your vehicle with four wheels on the ground.



- 3-1. Using the air conditioning system and defogger ..... 162**
  - Automatic air conditioning system (without navigation system)..... 162
  - Rear cooler system..... 168
  - Rear window and outside rear view mirror defoggers..... 169
  
- 3-2. Using the audio system ..... 171**
  - Audio system type ..... 171
  - Using the radio..... 173
  - Using the CD player..... 181
  - Playing MP3 and WMA discs ..... 188
  - Optimal use of the audio system ..... 194
  - Using the AUX adapter ..... 197
  - Using the steering switches..... 198
  
- 3-3. Using the rear audio system ..... 200**
  - Rear seat entertainment system features ..... 200
  - Using the DVD player (DVD video)..... 205
  - Using the DVD player (video CD)..... 212
  - Using the DVD player (audio CD/CD text)..... 214
  - Using the DVD player (MP3 discs)..... 215
  - Using the video mode..... 217
  - Changing the initial setting ..... 218
  
- 3-4. Using the interior lights ..... 225**
  - Interior lights list ..... 225
  
- 3-5. Using the storage features ..... 228**
  - List of storage features ..... 228
  
- 3-6. Other interior features..... 233**
  - Sun visors ..... 233
  - Vanity mirror ..... 234
  - Clock..... 235
  - Outside temperature display ..... 236
  - Ashtrays ..... 237
  - Cigarette lighter ..... 238
  - Power outlet ..... 239
  - Seat heaters ..... 241
  - Armrest..... 243
  - Floor mats ..... 244
  - Luggage compartment features..... 245
  - Garage door opener..... 248
  - Compass ..... 253
  - Lexus Link System ..... 257

### 3-1. Using the air conditioning system and defogger

## Automatic air conditioning system (without navigation system)

Airflow and outlets are automatically adjusted according to the temperature setting.

Owners of models equipped with a navigation system should refer to the “Navigation System Owner’s Manual”.

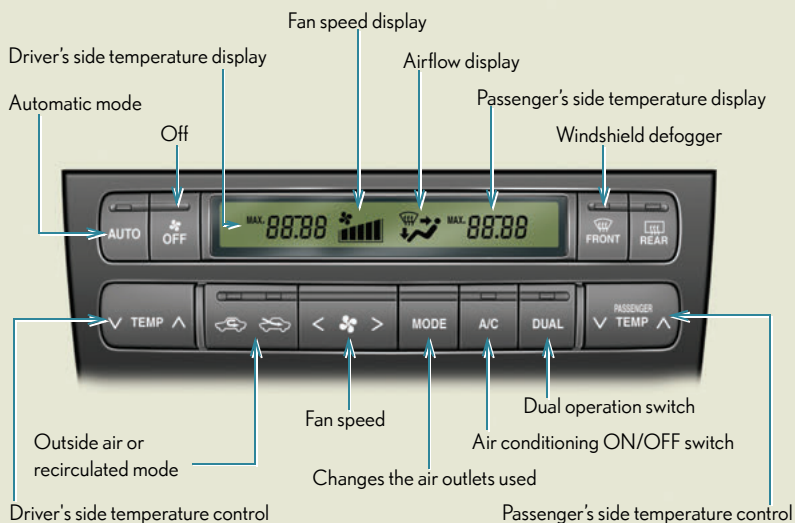

### Using the automatic mode

**STEP 1** Press  .

➔ The air conditioning system will begin to operate. Air outlets and fan speed are automatically adjusted according to the temperature setting.



**STEP 2** Press  $\wedge$  to increase the temperature and  $\vee$  to decrease the temperature on the  .

The temperature for the driver and passenger seats can be set separately.

## Adjusting the settings

### ■ Adjusting the temperature setting

Press  $\wedge$  to increase the temperature and  $\vee$  to decrease the temperature on the .

Press  $\wedge$  (increase) or  $\vee$  (decrease) on the  to separately adjust the temperature for the passenger and driver sides (dual mode). Press  to return the driver and passenger side temperatures to the same setting (simultaneous mode).

The air conditioning system switches between dual and simultaneous modes each time  is pressed.

### ■ Adjusting the fan speed

Press  $\wedge$  (increase) or  $\vee$  (decrease) on the  button.

Press  to turn the fan off.

### 3-1. Using the air conditioning system and defogger

#### ■ Changing the air outlets

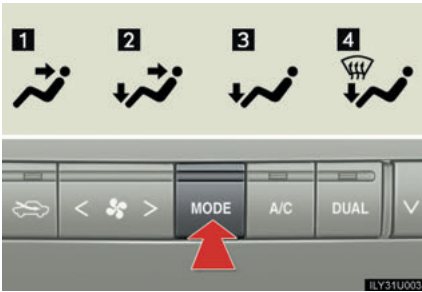

Press  .

The air outlets switch each time the button is pressed.

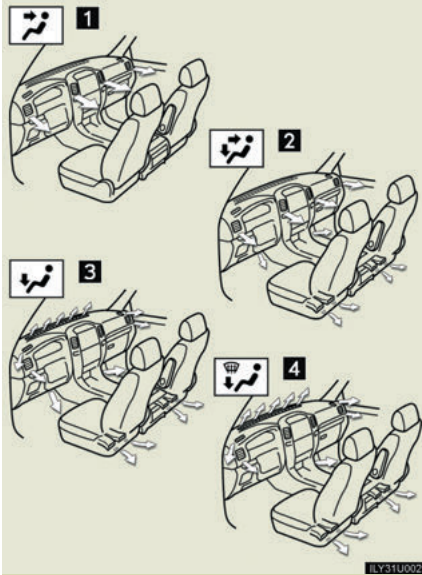

1 Air flows to the upper body.



2 Air flows to the upper body and feet.

3 Air flows to the feet.

4 Air flows to the feet and the windshield defogger operates.

#### ■ Switching between outside air and recirculated air modes

Press  .

The mode switches between  (recycles air inside the vehicle) and  (introduces air from outside the vehicle) modes each time the button is pressed.

## Defogging the windshield

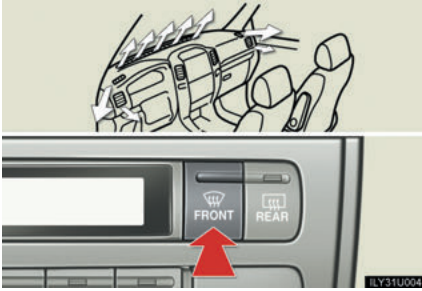

Press .

The air conditioning system control operates automatically.

## Adjusting the position of and opening and closing the air outlets

### ► Center outlets

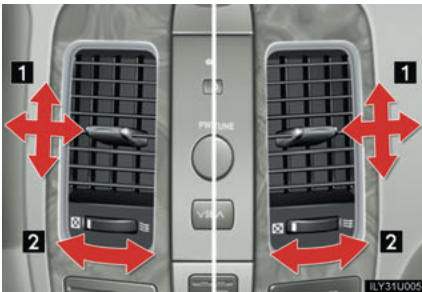

- 1 Direct air flow to the left or right, up or down
- 2 Turn the knob to open or close the vent

### ► Side outlets



- 1 Direct air flow to the left or right, up or down
- 2 Turn the knob right to open the vent and left to close the vent

### ■ Using the automatic mode

Fan speed is adjusted automatically in accordance with the temperature setting and ambient conditions. As a result, the following may occur.

- The system may switch automatically to recirculated mode when the coolest temperature setting is selected in summer.
- Immediately after the switch is pressed, the fan may stop for a while until warm or cool air is ready to flow.
- Cool air may flow to the area around the upper body when the heater is on.

### ■ Using the system in recirculated air mode

The windows will fog up more easily if the recirculated air mode is used for an extended period.

### ■ Window defogger feature

Recirculated air mode may automatically switch to  (outside air) mode in situations where the windows need to be defogged.

### ■ Outside temperature approaches 32°F (0°C).

The air conditioning system may not operate even when  is pressed.

### ■ When the indicator light on flashes

Press  and turn off the air conditioning system before turning it on once more. There may be a problem in the air conditioning system if the indicator light continues to flash. Turn the air conditioning system off and have it inspected by your Lexus dealer.

 CAUTION

■ **To prevent the windshield from fogging up**

Do not use  during cool air operation in extremely humid weather. The difference between the temperature of the outside air and that of the windshield can cause the outer surface of the windshield to fog up, blocking your vision.

 NOTICE

■ **To prevent battery discharge**

Do not leave the automatic air conditioning system on longer than necessary when the engine is stopped.

### 3-1. Using the air conditioning system and defogger

## Rear cooler system

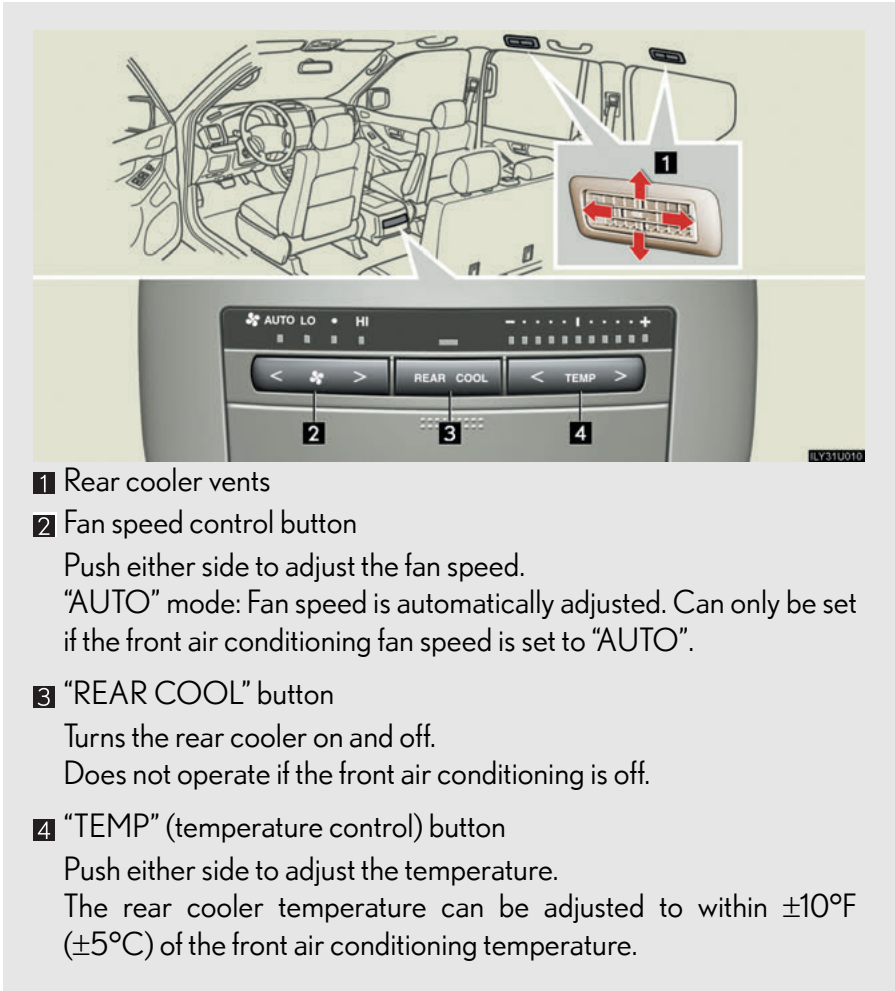

1 Rear cooler vents

2 Fan speed control button

Push either side to adjust the fan speed.

“AUTO” mode: Fan speed is automatically adjusted. Can only be set if the front air conditioning fan speed is set to “AUTO”.

3 “REAR COOL” button

Turns the rear cooler on and off.

Does not operate if the front air conditioning is off.

4 “TEMP” (temperature control) button

Push either side to adjust the temperature.

The rear cooler temperature can be adjusted to within  $\pm 10^{\circ}\text{F}$  ( $\pm 5^{\circ}\text{C}$ ) of the front air conditioning temperature.

#### NOTICE

##### To prevent battery discharge

Do not leave the rear cooler on longer than necessary when the engine is off.



### 3-1. Using the air conditioning system and defogger

## Rear window and outside rear view mirror defoggers

These features are used to defog the rear window, and to remove rain-drops, dew and frost from the outside rear view mirrors.

#### ■ Rear window defogger

▶ With navigation system



ON/OFF

▶ Without navigation system



ON/OFF

#### ■ Outside rear view mirror defogger



ON/OFF

### ■ Operating conditions

The ignition switch must be in the "ON" position.

### ■ Auto shut-off function

The system will automatically shut off after operating for 15 minutes.

### CAUTION

#### ■ When the outside rear view mirror defoggers are on

Do not touch the rear view mirror surfaces, as they can become very hot and burn you.

### NOTICE

#### ■ To prevent battery discharge

Turn the defoggers off when the engine is off.

## 3-2. Using the audio system

### Audio system type

Owners of models equipped with a navigation system should refer to the “Navigation System Owner’s Manual”.

CD player with changer and AM/FM radio.



If a Mark Levinson audio system is installed, the “Mark Levinson” logo is shown on the panel.

Title	Page
Using the radio	P.173
Using the CD player	P.181
Playing MP3 and WMA discs	P.188
Optimal use of the audio/video system	P.194
Using the AUX adapter	P.197
Using the steering switches	P.198

### ■ Using cellular phones

Interference may be heard through the audio system's speakers if a cellular phone is being used inside or close to the vehicle while the audio system is operating.

### CAUTION

#### ■ For vehicles sold in the U.S.A. and Canada

##### ● Part 15 of the FCC Rules

FCC Warning:

Any unauthorized changes or modifications to this equipment will void the user's authority to operate this device.

##### ● Laser products

- Do not take this unit apart or attempt to make any changes yourself. This is an intricate unit that uses a laser pickup to retrieve information from the surface of compact discs. The laser is carefully shielded so that its rays remain inside the cabinet. Therefore, never try to disassemble the player or alter any of its parts since you may be exposed to laser rays and dangerous voltages.
- This product utilizes a laser. Use of controls or adjustments or performance of procedures other than those specified herein may result in hazardous radiation exposure.

### NOTICE

#### ■ To prevent battery discharge

Do not leave the audio system on longer than necessary with the engine off.

#### ■ To avoid damaging the audio/video system

Take care not to spill drinks or other fluids over the audio system.



## 3-2. Using the audio system

### Using the radio

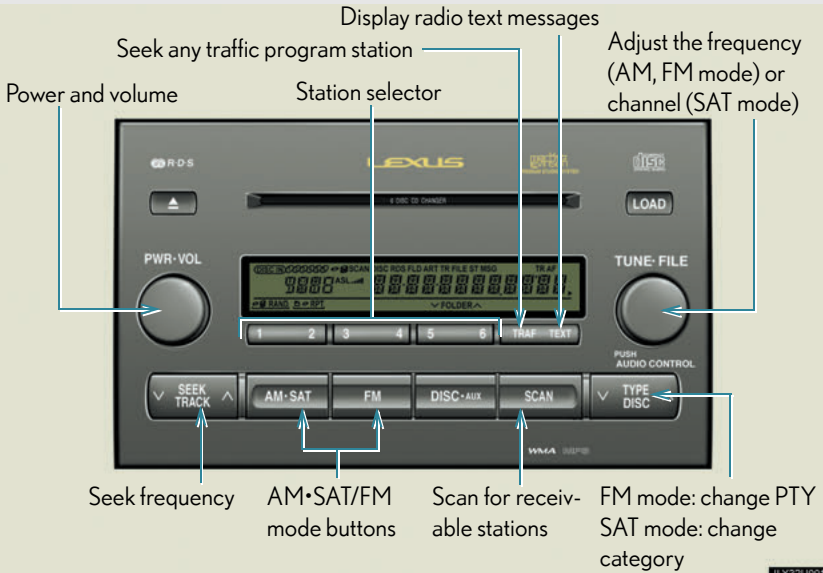
Press **AM-SAT** or **FM** to choose either an AM or FM band.



### Setting station presets (excluding XM<sup>®</sup> satellite radio)

**STEP 1** Search for desired stations by turning the  dial or pressing  ^ or v on .

**STEP 2** Touch and hold one of the preset stations (1 - 6) until you hear a beep.

### Scanning radio stations (excluding XM<sup>®</sup> satellite radio)

#### ■ Scanning the preset radio stations

**STEP 1** Press and hold  until you hear a beep.

Preset stations will be played for a few seconds each.

**STEP 2** When the desired station is reached, press the button once again.

#### ■ Scanning all radio stations within range

**STEP 1** Press .

“SCAN” appears on the display and all stations with reception will be played for a few seconds each.

**STEP 2** When the desired station is reached, press the button once again.

## RDS (Radio Data System)

This feature allows your radio to receive station identification information and program information (classical, jazz, etc.) from radio stations which broadcast this information.

### ■ Receiving RDS broadcasts

**STEP 1** Press  $\wedge$  or  $\vee$  on the  button during FM reception. The type of program changes each time the button is pressed.

- ROCK
- EASYLIS (Easy listening)
- CLS/JAZZ (Classical music and Jazz)
- R & B (Rhythm and Blues)
- INFORM (Information)
- RELIGION
- MISC (Miscellaneous)
- ALERT (Emergency messages)

If the system receives no RDS stations, "NO PTY" appears on the display.

**STEP 2** Press , or  $\wedge$  or  $\vee$  on .

The radio seeks or scans the station by the relevant program type.

If no radio station of that type is found, "NOTHING" appears on the screen.

■ **Displaying radio station names**

Press .

■ **Displaying radio text messages**

Press .

If MSG shows in the display, a text message will be displayed.

If the text continues past the end of the display, > is displayed. Press and hold  until you hear a beep.

■ **Traffic announcement**

Press .

“TRAF SEEK” appears on the display, and the radio will start seeking any station broadcasting traffic program information.

If no traffic program station is found, “NO TRAF INFO” appears on the display.



**XM<sup>®</sup> satellite radio**

■ **Receiving XM<sup>®</sup> satellite radio**

**STEP 1** Press  until “SAT” appears on the display.

The display changes as follows each time the switch is pressed.

AM → SAT1 → SAT2 → SAT3

**STEP 2** Turn the  dial to select a desired channel from all the categories or press ^ or v on  to select a desired channel in the current category.



### ■ Presetting XM<sup>®</sup> satellite radio channels

Select the desired channel. Touch one of the preset stations (1 - 6) and hold it until you hear a beep.

### ■ Changing the channel category

Press  $\wedge$  or  $\vee$  on .

### ■ Scanning XM<sup>®</sup> satellite radio channels

#### ● Scanning channels in the current category

**STEP 1** Press .

“SCAN” appears on the screen.

**STEP 2** When the desired channel is reached, press the button again.

#### ● Scanning preset channels

**STEP 1** Press and hold  until you hear a beep.

**STEP 2** When the desired channel is reached, press the button again.

### ■ Displaying text information

Press .

The display will show up to 10 characters.

### ■ When the battery is disconnected

All preset stations are erased.

### ■ Reception sensitivity

- Maintaining perfect radio reception at all times is difficult due to the continually changing position of the antenna, differences in signal strength and surrounding objects, such as trains, transmitters, etc.
- The radio antenna is mounted inside the quarter window. To maintain clear radio reception, do not attach metallic window tinting or other metallic objects to the antenna wire mounted inside the quarter window.

### ■ XM<sup>®</sup> satellite radio

The optional Lexus genuine satellite radio tuner and antenna allows you to receive and play XM<sup>®</sup> satellite radio broadcasts. (Subscription is required. Not available in Hawaii and Alaska.)\*

#### ● XM<sup>®</sup> subscriptions

For detailed information about XM<sup>®</sup> satellite radio or to subscribe, visit XM<sup>®</sup> on the web at [www.xmradio.com](http://www.xmradio.com) or call (800) 967-2346.

#### ● Radio ID

You will need the radio ID when activating XM<sup>®</sup> service or reporting a problem. Select "CH000" using the  dial, and the receiver's 8-character ID number will appear.

#### ● Satellite tuner

The tuner supports only Audio Services (Music and Talk) and the accompanying Text Information of XM<sup>®</sup> satellite radio.

\*: Terms and services provided by XM<sup>®</sup> Radio are subject to change without notice.

■ **If the satellite radio does not operate normally**

If a problem occurs with the XM<sup>®</sup> tuner, a message will appear on the screen. Refer to the table below to identify the problem, and take the suggested corrective action.

ANTENNA	The XM <sup>®</sup> antenna is not connected. Check whether the XM <sup>®</sup> antenna cable is attached securely.
	There is a short-circuit in the antenna or the surrounding antenna cable. See a Lexus certified dealer.
UPDATING	You have not subscribed to XM <sup>®</sup> satellite radio. The radio is being updated with the latest encryption code. Contact XM <sup>®</sup> satellite radio for subscription information. When a contract is canceled, you can choose "CH000" and all free-to-air channels.
	The premium channel you selected is not authorized. Wait for about 2 seconds until the radio returns to the previous channel or "CH001". If it does not change automatically, select another channel. If you want to listen to the premium channel, contact XM <sup>®</sup> satellite radio.
NO SIGNAL	The XM <sup>®</sup> signal is too weak at the current location. Wait until your vehicle reaches a location with a stronger signal.
LOADING	The unit is acquiring audio or program information. Wait until the unit has received the information.
OFF AIR	The channel you selected is not broadcasting any programming. Select another channel.
-----	There is no song/program title or artist name/feature associated with the channel at that time. No action needed.

---

The channel you selected is no longer available. Wait for about 2 seconds until the radio returns to the previous channel or "CH001". If it does not change automatically, select another channel.

Contact the XM<sup>®</sup> Listener Care Center at (800) 967-2346 during the following hours\*.

Monday - Saturday: 6 a.m. - 2 a.m. Sunday: 8 a.m. - 8 p.m. ET

\*: Subject to change without notice.

### ■ Certifications for the radio tuner

This equipment has been tested and found to comply with the limits for a class B digital device, pursuant to Part 15 of the FCC Rules. These limits are designed to provide reasonable protection against harmful interference in a residential installation. This equipment generates, uses and can radiate radio frequency energy and, if not installed and used in accordance with the instructions, may cause harmful interference to radio communications. However, there is no guarantee that interference will not occur in a particular installation.

If this equipment does cause harmful interference to radio or television reception, which can be determined by turning the equipment off and on, the user is encouraged to try to correct the interference by trying one or more of the following:

- Reorienting or relocating the receiving antenna.
- Increasing the separation between the equipment and receiver.
- Connecting the equipment into an outlet on a circuit different from that to which the receiver is connected.
- Consulting the dealer or an experienced radio/TV technician for help.

## 3-2. Using the audio system Using the CD player

Insert a CD or press **DISC+AUx** with a CD inserted.

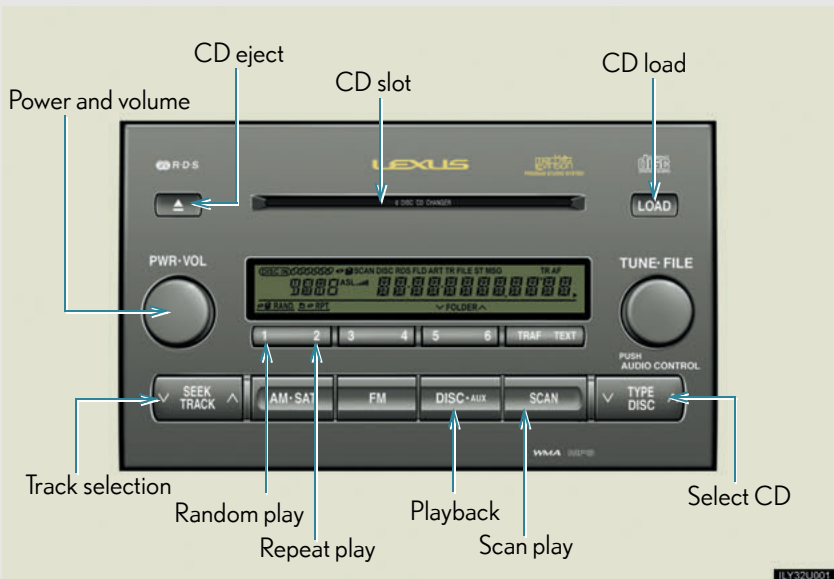

## Loading a CD

### ■ Loading a single CD

**STEP 1** Press **LOAD**.

**STEP 2** When the indicator changes from flashing amber to green, insert a CD.

The display changes from “WAIT” to “LOAD”.

### ■ Loading multiple CDs

**STEP 1** Press and hold **LOAD** until you hear a beep.

**STEP 2** When the indicator changes from flashing amber to green, insert a CD.

**STEP 3** After inserting a CD, wait until the indicator changes from flashing amber to green, then insert the next CD.

Repeat steps 2 and 3 until you have inserted all CDs.

To cancel the operation, press the **LOAD** or **DISC+ALL** button. If you do not insert a CD within 15 seconds, loading will be canceled automatically.

## Ejecting CDs

### ■ Ejecting a CD



To select the CD to be ejected, press **^** or **v** on **TYPE DISC**.

The number of the CD selected is shown on the display.

**STEP 2** Press **▲** and remove the CD.

### ■ Ejecting all CDs

Press and hold **▲** until you hear a beep, then remove the CDs.

## Selecting, fast forwarding, rewinding, and scanning tracks

### ■ Selecting a track

Press  $\wedge$  to move up and  $\vee$  to move down using  until the desired track number is displayed.

To fast forward or rewind, press and hold  $\wedge$  or  $\vee$  on .

### ■ Scanning a CD

**STEP 1** Press .

“SCAN” appears on the display.

The first 10 seconds of each track will be played.

**STEP 2** Press the button again when the desired track is reached.

## Selecting a CD

### ■ To select a CD to play

To select the desired CD, press  $\wedge$  or  $\vee$  on .

### ■ To scan loaded CDs

**STEP 1** Press and hold  until you hear a beep.

The first 10 seconds of the first track on each CD will be played.

**STEP 2** Press the button again when the desired CD is reached.

## Random play

### ■ Current CD

Press  (RAND).

Songs are played in random order until random play is canceled.

### ■ All CDs

Press and hold  (RAND) until you hear a beep.

Tracks on all loaded CDs are played in random order until the button is pressed once again.

## Repeating a track or a disc

### ■ Repeating a track

Press  (RPT).

### ■ Repeating a disc

Press and hold  (RPT) until you hear a beep.

---

### ■ Canceling random, repeat and scan playback

Press  (RAND, RPT), or  again.

### ■ Displaying the title and artist name

If a CD-TEXT disc is inserted, the title of the disc and track will be displayed. Up to 12 letters can be displayed.

### ■ When “ERROR” or “WAIT” is shown on the display.

“ERROR”: This indicates trouble either with the CD or within the player. The CD may be dirty, damaged, or inserted upside down.

“WAIT”: Operation is stopped due to high temperature inside the player. Wait for a while and then press . Contact your Lexus dealer if the CD still cannot be played.



### ■ CD compatibility



Only audio CDs with the marks shown to the left can be used.

The following products may not be playable on your CD player.

- SACDs
- dts-CDs
- Copy-protected CDs

### ■ CD player protection feature

To protect the internal components, playback is automatically stopped when a problem is detected.

#### ■ If CDs are left inside the CD player or in the ejected position for extended periods

CDs may be damaged and may not play properly.

#### ■ Lens cleaners

Do not use lens cleaners. Doing so may damage the CD player.

 NOTICE

■ Discs and adapters that cannot be used

Do not use the following types of discs, 3 in. (8 cm) disc adapters or Dual Disc. Doing so may damage the player and render the disc insert/eject function unusable.



- Discs that have a diameter that is not 4.7 in. (12 cm).

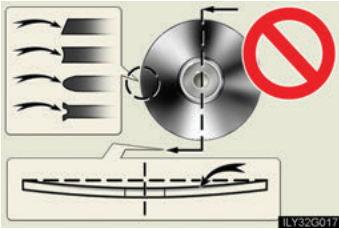

- Low-quality and deformed discs.

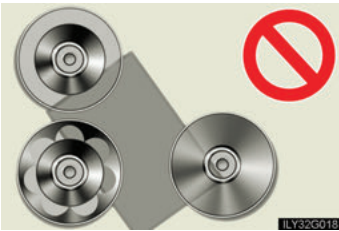

- Discs with a transparent or translucent recording area.



- Discs that have tape, stickers or CD-R labels attached to them, or that have the label peeled off.

 NOTICE**■ Player precautions**

Failure to follow the precautions below may result in damage to the discs or the player itself.

- Do not insert anything other than discs into the disc slot.
- Do not apply oil to the player.
- Store discs away from direct sunlight.
- Never try to disassemble any part of the player.



- Do not insert more than one disc at a time.

## 3-2. Using the audio system Playing MP3 and WMA discs

Insert an MP3 or WMA disc or press **DISC-AUX** with a disc inserted.

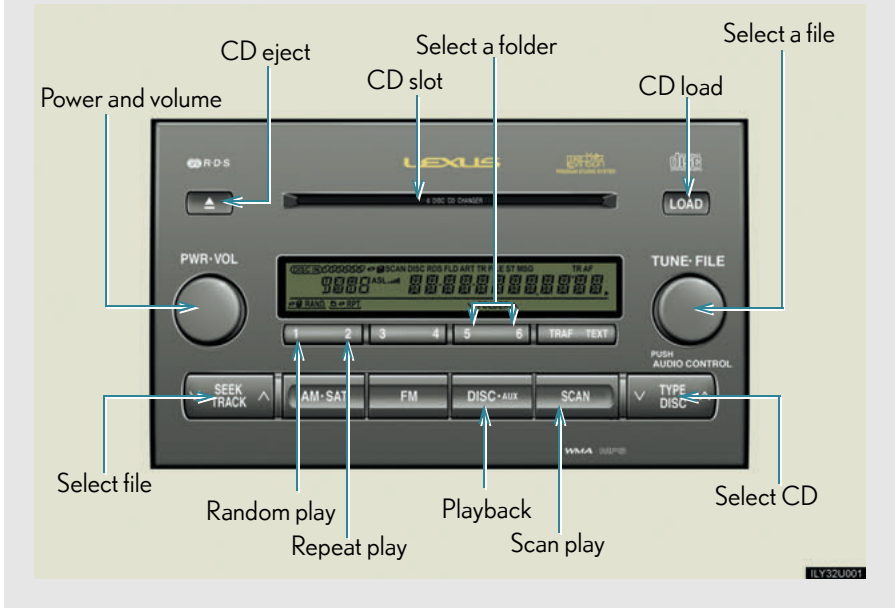

### Loading, ejecting and selecting MP3 and WMA discs

Refer to the section titled “Using the CD player” for details. (→P. 181)

### Selecting a folder

#### ■ Selecting a folder

Press **5** or **6** ( $\wedge$  or  $\vee$ ) to select the previous/next folder.

#### ■ Selecting the desired folder by cueing the first file of each folder

Press and hold **SCAN** until you hear a beep.

## Selecting and scanning files

### ■ Selecting one file at a time

Turn the  dial or press  $\wedge$  or  $\vee$  on  to select the desired file.

### ■ Selecting a desired file by cueing the files in the folder

Press .

When the desired file is reached, press the switch once again.

## File repeat

Press  (RPT).

## Folder repeat

Press and hold  (RPT) until you hear a beep.

## Random play

### ■ To play files from a particular folder in random order

Press  (RAND).

### ■ To play all the files on a disc in random order

Press and hold  (RAND) until you hear a beep.

### ■ Canceling random, repeat and scan play

Press  (RAND, RPT), or  again.

### ■ Error messages

→P.184

### ■ CD player protection feature

To protect the internal components, playback is automatically stopped when a problem is detected while the CD player is being used.

### ■ If CDs are left inside the CD player or in the ejected position for extended periods

CDs may be damaged and may not play properly.

### ■ Lens cleaners

Do not use lens cleaners. Doing so may damage the CD player.

### ■ MP3 and WMA files

MP3 (MPEG Audio LAYER 3) is a standard audio compression format.

Files can be compressed to approximately 1/10 of their original size by using MP3 compression.

WMA (Windows Media <sup>TM</sup>Audio) is a Microsoft audio compression format.

This format compresses audio data to a size smaller than that of the MP3 format.

There is a limit to the MP3 and WMA file standards and to the media/formats recorded by them that can be used.

#### ● MP3 file compatibility

- Compatible standards  
MP3 (MPEG1 LAYER3, MPEG2 LSF LAYER3)
- Compatible sampling frequencies  
MPEG1 LAYER3: 32, 44.1, 48 (kHz)  
MPEG2 LSF LAYER3: 16, 22.05, 24 (kHz)
- Compatible bit rates  
MPEG1 LAYER3: 64, 80, 96, 112, 128, 160, 192, 224, 256, 320 (kbps)
- MPEG2 LSF LAYER3: 64, 80, 96, 112, 128, 144, 160 (kbps)  
\*: Compatible with VBR
- Compatible channel modes: stereo, joint stereo, dual channel and monaural

- WMA file compatibility

- Compatible standards  
WMA Ver. 7, 8, 9
- Compatible sampling frequencies  
32, 44.1, 48 (kHz)
- Compatible bit rates  
Ver. 7, 8: CBR 48, 64, 80, 96, 128, 160, 192 (kbps)  
Ver. 9: CBR 48, 64, 80, 96, 128, 160, 192, 256, 320 (kbps)  
\*: Only compatible with 2-channel playback

- Compatible media

Media that can be used for MP3 and WMA playback are CD-Rs and CD-RWs.

Playback in some instances may not be possible, depending on the status of the CD-R or CD-RW. Playback may not be possible or the audio may jump if the disc is scratched or marked with fingerprints.

- Compatible disc formats

The following disc formats can be used.

- Disc formats: CD-ROM Mode 1 and Mode 2  
CD-ROM XA Mode 2, Form 1 and Form 2
- File formats: ISO9660 level 1, level 2, (Romeo, Joliet)  
MP3 and WMA files written in any format other than those listed above may not play correctly, and their file names and folder names may not be displayed correctly.

Items related to standards and limitations are as follows:

- Maximum directory hierarchy: 8 levels
- Maximum length of folder names/file names: 32 characters
- Maximum number of folders: 192 (including the root)
- Maximum number of files per disc: 255

- File names

The only files that can be recognized as MP3/WMA and played are those with the extension .mp3 or .wma.

- Multi-sessions

As the audio system is compatible with multi-sessions, it is possible to play discs that contain MP3 and WMA files. However, only the first session can be played.

### ● ID3 and WMA tags

ID3 tags can be added to MP3 files, making it possible to record the track title and artist name, etc.

The system is compatible with ID3 Ver. 1.0, 1.1, and Ver. 2.2, 2.3 ID3 tags. (The number of characters is based on ID3 Ver. 1.0 and 1.1.)

WMA tags can be added to WMA files, making it possible to record the track title and artist name in the same way as with ID3 tags.

### ● MP3 and WMA playback

When a disc containing MP3 or WMA files is inserted, all files on the disc are first checked. Once the file check is finished, the first MP3 or WMA file is played. To make the file check finish more quickly, we recommend you do not write in any files other than MP3 or WMA files or create any unnecessary folders.

Discs that contain a mixture of music data and MP3 or WMA format data cannot be played.

### ● Extensions

If the file extensions .mp3 and .wma are used for files other than MP3 and WMA files, they will be mistakenly recognized and played as MP3 and WMA files. This may result in large amounts of interference and damage to the speakers.

### ● Playback

- To play MP3 files with steady sound quality, we recommend a fixed bit rate of 128 kbps and a sampling frequency of 44.1 kHz.
- CD-R or CD-RW playback may not be possible in some instances, depending on the characteristics of the disc.
- There is a wide variety of freeware and other encoding software for MP3 and WMA files on the market, and depending on the status of the encoding and the file format, poor sound quality or noise at the start of playback may result. In some cases, playback may not be possible at all.
- When files other than MP3 or WMA files are recorded on a disc, it may take more time to recognize the disc and in some cases, playback may not be possible at all.
- Microsoft, Windows, and Windows Media are the registered trademarks of Microsoft Corporation in the U.S. and other countries.



### ■ CD-R and CD-RW discs

- CD-R/CD-RW discs that have not been subject to the “finalizing process” (a process that allows discs to be played on a conventional CD player) cannot be played.
- It may not be possible to play CD-R/CD-RW discs recorded on a music CD recorder or a personal computer because of disc characteristics, scratches or dirt on the disc, or dirt, condensation, etc. on the lens of the unit.
- It may not be possible to play discs recorded on a personal computer depending on the application settings and the environment. Record with the correct format. (For details, contact the appropriate application manufacturers of the applications.)
- CD-R/CD-RW discs may be damaged by direct exposure to sunlight, high temperatures or other storage conditions. The unit may be unable to play damaged discs.
- If you insert a CD-RW disc into the MP3/WMA player, playback will begin more slowly than with a conventional CD or CD-R disc.
- Recordings on CD-R/CD-RW cannot be played using the DDCD (Double Density CD) system.

### ■ Unsuitable discs, and player precautions

→P.186

## 3-2. Using the audio system

# Optimal use of the audio system



## Adjusting sound quality, volume, balance and sound level

### ■ Changing sound quality modes

Push  to change the sound mode in the following order.

BAS → MID → TRE → FAD → BAL → ASL → POS\*

\*: For a Mark Levinson brand audio system is not available.

## ■ Adjusting sound quality

Turn the  dial to the left or right.

Sound quality mode	Mode displayed	Level	Turn to the left	Turn to the right
Bass	BAS	-5 to 5	Low	High
Midrange	MID	-5 to 5		
Treble	TRE	-5 to 5		
Forward-rear balance	FAD	F7 to R7	Shifts to rear	Shifts to front
Left-right balance	BAL	L7 to R7	Shifts to left	Shifts to right
Surround*	SUR-ROUND	ON/OFF	OFF	ON

\*: Mark Levinson brand audio system only.

## ■ Adjusting the Automatic Sound Levelizer (ASL)

ASL automatically adjusts the volume and tone quality according to the noise level as you drive your vehicle.

Turn  while the ASL mode is displayed to turn on or off the automatic sound levelizer.

**Changing the listening position (For a Mark Levinson brand audio system is not available)**

The speaker balance can be changed to produce the best sound for each listening position.



Turn the dial while "POS" is shown on the display.

The listening position changes as follows each time the switch is touched.

Display	Listening position
DRIVER	Position best suited to the driver's seat
FRONT	Position best suited to the driver's and front passenger's seat
REAR	Position best suited to the rear seats
ALL	Position best suited to all seats

## 3-2. Using the audio system

### Using the AUX adapter

This adapter can be used to connect a portable audio device and listen to it using the vehicle's speakers.



Connect the portable audio device.

**STEP 2** Press .

#### ■ Operating portable audio devices connected to the audio system

The volume can be adjusted using the vehicle's audio controls. All other adjustments must be made on the portable audio device itself.

## 3-2. Using the audio system

# Using the steering switches

Some audio features can be controlled using the steering switches.

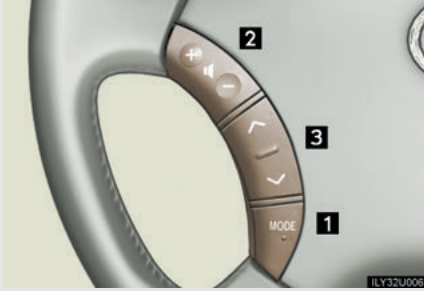

- 1 Power on, select audio source
- 2 Volume
- 3 Radio: Select radio stations  
CD: Select tracks and discs

### Turning on the power

Press  when the audio system is off.

The audio system can be turned OFF by holding the switch down for 1 second or more.

### Changing the audio source

Press  when the audio system is on. The audio source changes as follows each time the button is pressed. If a CD is not inserted, that mode will be skipped.

FM (1, 2) → CD player → AUX → AM → SAT (1, 2, 3)

### Adjusting the volume

Press "+" on  to increase the volume and "-" to decrease the volume.

Hold down the button to continue increasing or decreasing the volume.

## Selecting a radio station

**STEP 1** Press  to select the radio mode.

**STEP 2** Press  $\wedge$  or  $\vee$  on  to select a radio station.

To seek for receivable stations, press and hold the switch until you hear a beep.

## Selecting a track

**STEP 1** Press  to select the CD player.

**STEP 2** Press  $\wedge$  or  $\vee$  on  to select the desired track.

## Selecting a disc

**STEP 1** Press  to select the CD player.

**STEP 2** Press and hold  $\wedge$  or  $\vee$  on  until you hear a beep.

### CAUTION

#### To reduce the risk of an accident

Exercise care when operating the audio switches on the steering wheel.

### 3-3. Using the rear audio system

## Rear seat entertainment system features (if equipped)

The rear seat entertainment system is designed for the rear passengers to enjoy audio and DVD video separately from the front audio system.

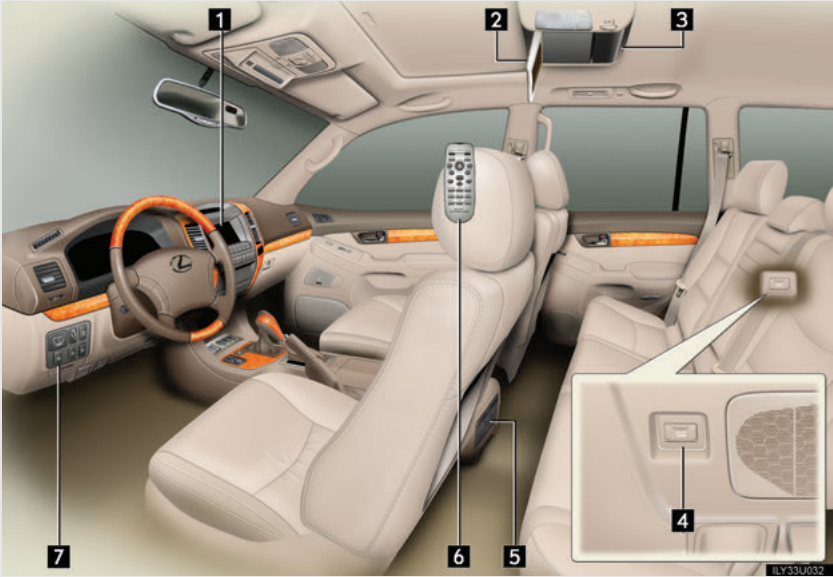

- 1 Front audio system
- 2 Display
- 3 DVD player
- 4 Power outlet
- 5 Headphone volume control dials, headphone jacks and A/V input adapter
- 6 Rear seat entertainment system controller
- 7 Power outlet main switch



## Opening and closing the display

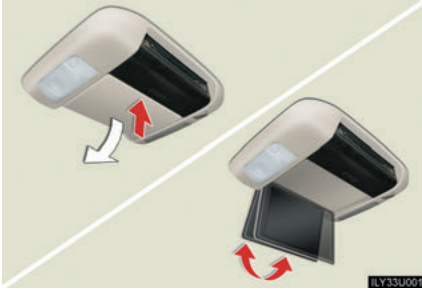

Press the lock release button to open the display.

Pull the display down to an easily viewable angle (between 90° and 125°).



To close the display, press the display up until a click is heard.

The screen is automatically turned off when the display is closed. However, the rear seat entertainment system is not turned off.

## Loading a disc

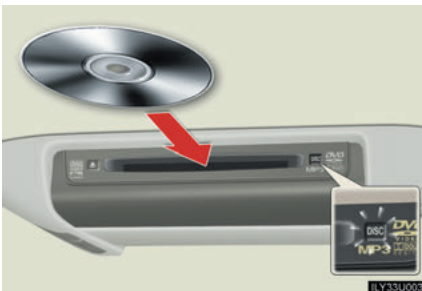

Insert the disc into the slot with the label side up.

The DISC indicator light turns on while the disc is loaded.

The player will play the track or chapter, and will repeat it after it reaches the end.

## Ejecting a disc



Press  and remove the disc.

## Headphone jacks



**1** To use the headphones, connect them to the jack.

**2** To adjust the volume

Turn the dial clockwise to increase the volume, and counterclockwise to decrease the volume.

### ■ The rear seat entertainment system can be used when

The ignition switch is in the “ACC” or “ON” position.

### ■ Discs that can be used

Discs with the marks shown below can be used.

Playback may not be possible depending on recording format or disc features, or due to scratches, dirt or deterioration.



### ■ When appears on the screen

This indicates that the selected operation is not currently available.

### ■ Error messages

**DISC CHECK:** Indicates that the disc is dirty, damaged or was inserted upside down. Clean the disc or insert it correctly.

**REGION ERROR:** Indicates that the DVD region code is incorrect.

**DVD ERROR:** Indicates that there is a problem inside the player. Eject the disc, then reinsert it. If this problem persists, see your Lexus dealer. If the malfunction still exists, take the vehicle to your Lexus dealer.

### ■ Before using the remote control (for new vehicle owners)

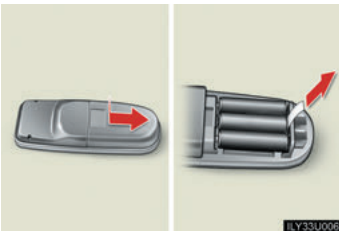

An insulating sheet is set to prevent the batteries from being discharged. Remove the insulating sheet before using the remote control.

#### ■ Headphones

Some headphones may not receive signals from the system clearly. Lexus recommends the use of Lexus genuine wireless headphones.

Please contact your Lexus dealer for further details.

#### ■ Volume

- Adjust the volume when you connect the headphones to the jack. Loud sounds may have a significant impact on the human body.
- Conversational speech on some DVDs is recorded at a low volume to emphasize the impact of sound effects. If you adjust the volume assuming that the conversations represent the maximum volume level that the DVD will play, you may be startled by louder sound effects or when you change to a different audio source. Be sure to adjust the volume with this in mind.

#### CAUTION

##### ■ While driving

Do not use headphones.

Doing so may cause an accident, resulting in death or serious injury.

##### ■ When the rear seat entertainment system is not used

Keep the display closed.

In the event of an accident or sudden braking, the opened display may hit an occupant's body, resulting in injury.

##### ■ To prevent accidents and electric shock

Do not disassemble or modify the remote control.

##### ■ When the remote control is not used

Stow the remote control to the remote control case.

Injuries may result in the event of an accident or sudden braking.

### 3-3. Using the rear audio system

## Using the DVD player (DVD video)

#### ■ Remote control

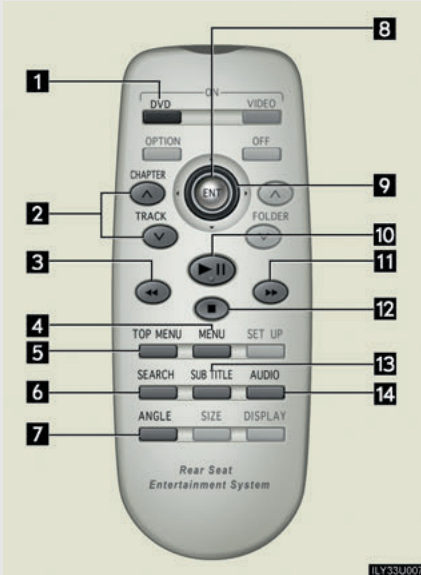

- 1 Turn on the DVD mode
- 2 Search a chapter
- 3 Rewind
- 4 Turn on the menu screen
- 5 Turn on the title selection screen
- 6 Search the title
- 7 Change the screen angle
- 8 Enter the selected option
- 9 Select an option
- 10 Play/pause
- 11 Fast forward
- 12 Stop
- 13 Change the subtitle language
- 14 Change the audio language

#### ■ Display (Page 1)

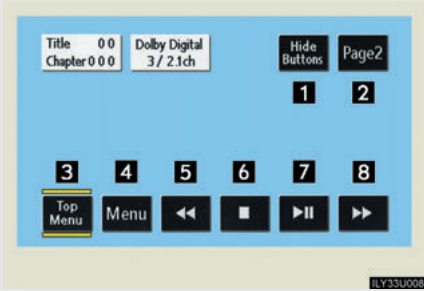

- 1 Turn off the operation switches on the display
- 2 Display Page 2
- 3 Turn on or off the title selection screen for the disc
- 4 Turn on or off the menu screen for the disc
- 5 Rewind
- 6 Stop
- 7 Pause/cancel pause
- 8 Fast forward

#### ■ Display (Page 2)



- 9 Display the initial setting screen
- 10 Display Page 1
- 11 Search for a title
- 12 Return to the previous screen
- 13 Change the audio language
- 14 Change the subtitle language
- 15 Change the angle

 NOTICE

### ■ Cleaning the display

Wipe the display with a dry soft cloth.

If the screen is wiped with a rough cloth, the surface of the screen may be scratched.

### ■ To prevent damage to the remote control

- Keep the remote control away from direct sunlight, high temperatures and high humidity.

- Do not drop or knock the remote control against hard objects.

- Do not sit on or place heavy objects on the remote control.

### ■ DVD player



Never try to disassemble or oil any part of the DVD player. Do not insert anything other than a disc into the slot.

## Turning the operation switches on and off



Press  to turn on the operation switches.

Press  once again or select  to turn off the operation switches.

## Turning on the title selection screen

Press  or select  to turn on the title selection screen. For operation of the title selection screen, see the manual that comes with the DVD disc.

## Turning on the menu screen

Press  or select  to turn on the menu screen. For operation of the title selection screen, see the manual that comes with the DVD disc.

### Returning to the previous screen

Press **Return** to return to the previous screen. For operation of the title selection screen, see the manual that comes with the DVD disc.

### Searching for a title

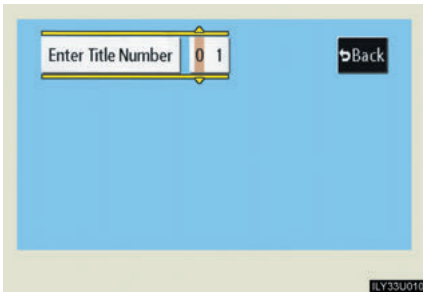

Press **SEARCH** or select **Search** to display the title search screen.

Select the title number, and press "ENT" to input it.

Select **Back** to return to the previous screen.

### Changing the subtitle language

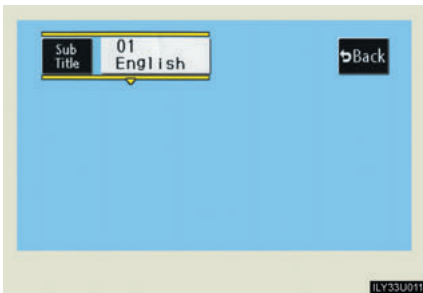

Press **SUB TITLE** or select **Sub Title** to display the subtitle language screen.

Each time **SUB TITLE** is pressed or **Sub Title** is selected, another language stored on the disc is selected.

Select **Back** to return to the previous screen.



## Changing the audio language

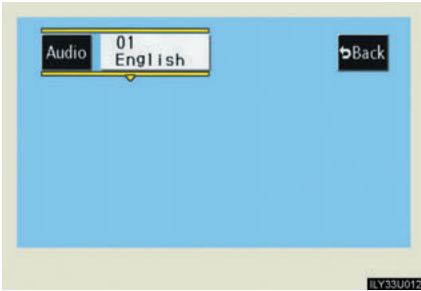

Press **AUDIO** or select **Audio** to display the audio language screen.

Each time **AUDIO** is pressed or **Audio** is selected, another language stored on the disc is selected.

Select **Back** to return to the previous screen.

## Changing the angle

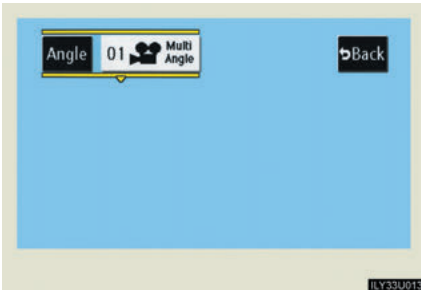

Press **ANGLE** or select **Angle** to display the screen to change the angle.

Each time **ANGLE** is pressed or **Angle** is selected, the angle changes.

Select **Back** to return to the previous screen.







### ■ DVD player and DVD video discs

This DVD player is compatible with NTSC color TV formats. DVD video discs conforming to other formats such as PAL or SECAM cannot be used.

### ■ Region codes

Some DVD video discs have a region code indicating where you can use them. If the DVD video disc is not labeled ALL or I, you cannot use it in this DVD player. If you attempt to play an inappropriate DVD video disc in this player, REGION CODE ERROR appears on the screen. Even if the DVD video disc does not have a region code, in some cases you cannot use it.

#### ■ Symbols shown on DVD video discs

	Indicates NTSC format.
	Indicates the number of audio tracks.
	Indicates the number of language subtitles.
	Indicates the number of angles.
	Indicates the screen display ratios available. Wide screen: 16:9 Standard: 4:3
	Indicates the disc's region code. All: all countries Number: region code

#### ■ DVD video disc glossary

- DVD video discs: Digital Versatile Discs that hold the world's standard video. DVD video discs have adopted "MPEG2", one of the world standards of digital compression technologies. The picture data is compressed by 1/40 on average and stored. Variable rate encoding technology has been adopted in which the volume of data assigned to the picture is changed depending on the picture format. Audio data is stored using PCM and Dolby digital, which enables higher sound. Furthermore, multi-angle and multi-language features will also help you enjoy the more advanced technology of DVD video.

- Viewer restrictions: This feature limits what can be viewed in conformity with the level of restrictions of the country. The level of restrictions varies depending on the DVD video disc. Some DVD video discs cannot be played at all, or violent scenes are skipped or replaced with other scenes.
  - Level 1: DVD video discs for children can be played.
  - Level 2 - 7: DVD video discs for children and G-rated movies can be played.
  - Level 8: All types of DVD video discs can be played.
- Multi-angle feature: Allows you to enjoy the same scene from different angles.
- Multi-language feature: Allows you to select the language of the subtitles and audio.
- Region codes: Region codes are found on DVD players and DVD discs. If a DVD video disc does not have the same region code as the DVD player, you cannot play the disc on that DVD player.
- Audio: This DVD player can play liner PCM, Dolby digital, dts and MPEG audio format DVD. Other decoded type cannot be played.
- Title and chapter: Video and audio programs stored on DVD video discs are divided into sections by title and chapter.
- Title: The largest unit of the video and audio programs stored on DVD video discs. Usually, one movie, one album, or one audio program is assigned as a title.
- Chapter: A unit smaller than a title. A title comprises multiple chapters.

#### ■ Audio

Manufactured under license from Dolby Laboratories. "Dolby", "Pro Logic", and **DD** are trademarks of Dolby<sup>®</sup> Laboratories. Confidential unpublished works. 1992-1997 Dolby<sup>®</sup> Laboratories. All rights reserved.

"dts" is a trademark of Digital Theater Systems, Inc.

### 3-3. Using the rear audio system

## Using the DVD player (video CD)

#### ■ Remote control



- 1 Select a switch
- 2 Select a chapter
- 3 Play/pause
- 4 Rewind
- 5 Display operation switches
- 6 Enter the selected option
- 7 Fast forward
- 8 Stop
- 9 Change the initial setting

### ■ Display (page 1)

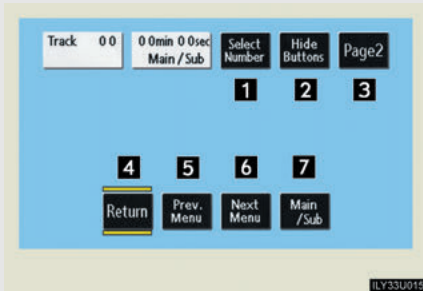

- 1 Select a disc menu number
- 2 Turn off the menu screen
- 3 Display page 2
- 4 Turn on the disc menu
- 5 Return to the previous page screen (with the disc menu displayed)
- 6 Proceed to the next page screen (with the disc menu displayed)
- 7 Change to a multiplex transmission

### ■ Display (page 2)

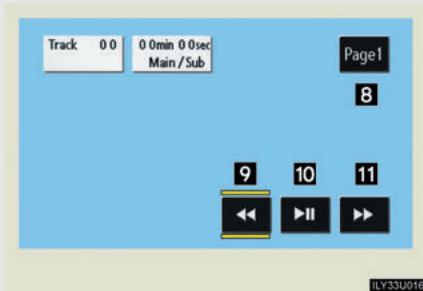

- 8 Display page 1
- 9 Rewind
- 10 Play/pause
- 11 Fast forward

## Selecting a disc menu number

Select **Select Number** to display the disc menu number search screen.

Select the disc menu number, and press “ENT” to input it.

Select **Back** to return to the previous screen.

### 3-3. Using the rear audio system

## Using the DVD player (audio CD/CD text)

#### ■ Control screen

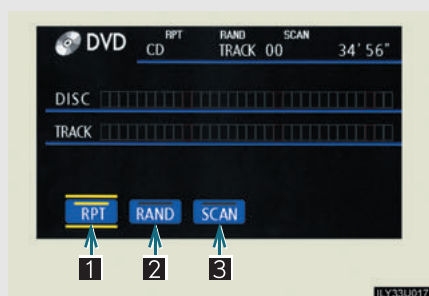

Press  to display the control screen.

- 1 Repeat play
- 2 Random play
- 3 Scan play

#### ■ Canceling random, repeat and scan play

Select ,  or  again.

### 3-3. Using the rear audio system

## Using the DVD player (MP3 discs)

#### ■ Control screen

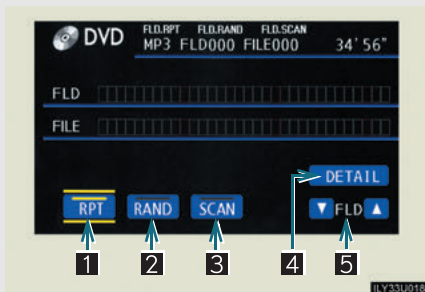

Press  to display the control screen.

- 1 Repeat play
- 2 Random play
- 3 Scan play
- 4 Display file information
- 5 Select a folder

#### Repeat play

##### ■ Repeat a file

Select .

##### ■ Repeat all of files in a folder

Select , and press and hold "ENT" on the remote control.

#### Random play

##### ■ Playing files from a particular folder in random order

Select .

##### ■ Playing all of the files on a disc in random order

Select , and press and hold "ENT" on the remote control.

## Scan play

### ■ Selecting the desired file by cueing the files in the folder

Select **SCAN**.

The player will scan all the files in the folder. Each file will be played for 10 seconds.

### ■ Selecting the desired file by cueing the folders on the disc

Select **SCAN**, and press and hold "ENT" remote control.

The player will scan all the folders on the disc. The first file in each folder will be played for 10 seconds.

---

### ■ Canceling random, repeat and scan play

Select **RPT**, **RAND** or **SCAN** again.



### 3-3. Using the rear audio system

## Using the video mode



Press **VIDEO** to select the video mode.

Before switching to the video mode, connect the audio machine to the input terminal adapter.

### Using the adapter

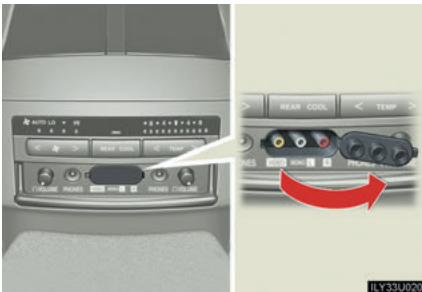

Open the cover.

The A/V input adapter is composed of 3 input adapters.

Yellow: Image input adapter

White: Audio input adapter

Red: Audio input adapter

#### ■ A/V input adapter

The rear seat entertainment system plays videos and sound when audio-video equipment is connected to the A/V input adapter. For details, refer to the manufacturer's instructions.

#### ■ Power outlet

The power outlet is used to connect the audio device. (→P. 239)

#### NOTICE

#### ■ When the A/V input adapter is not in use

Keep the A/V input adapter cover closed.

Inserting anything other than an appropriate plug may cause electrical failure or short circuit.

### 3-3. Using the rear audio system

## Changing the initial setting

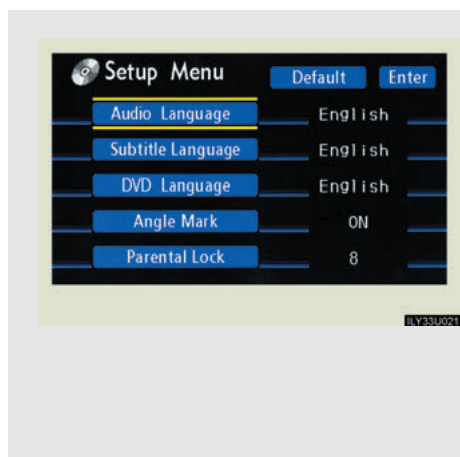

Press **SET UP** or select **Set Up** to display the initial settings screen.

The following settings can be changed here.

- Audio language
- Subtitle language
- DVD language
- Angle mark
- Parental lock

### Changing the audio language



Select "Audio Language".  
Select the language you want to hear, and press "ENT" to input it.

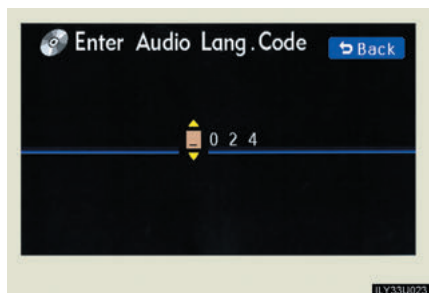

Select "Others" if you cannot find the language you want to hear.  
Enter the appropriate 4-digit language code. Select a number, and press "ENT" to input it.

Language code list (→P. 222)

If a code that is not in the list is entered, Incorrect Code will appear on the screen.

## Changing the subtitle language



Select "Subtitle Language".  
Select the desired language, and press "ENT" to input it.

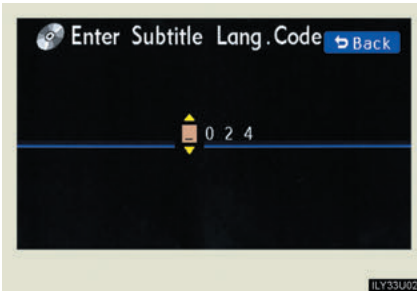

Select "Others" if you cannot find the desired language.  
Enter the appropriate 4-digit language code. Select a number, and press "ENT" to input it.

Language code list (→P. 222)

If a code that is not in the list is entered, Incorrect Code will appear on the screen.

## Changing the DVD language



Select "DVD Language".  
Select the desired language and press "ENT" to input it.

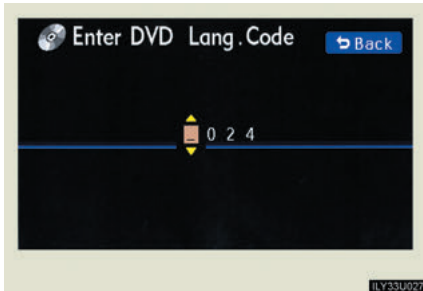

Select "Others" if you cannot find the desired language.

Enter the appropriate 4-digit language code. Select a number, and press "ENT" to input it.

Language code list (→P. 222)

If a code that is not in the list is entered, Incorrect Code will appear on the screen.

#### Turning the angle mark on and off

The angle mark can be turned on for discs that are multi-angle compatible.

Each time you press "ENT" when "Angle Mark" is selected, the angle mark turns on or off alternately.

#### Setting viewer restriction levels

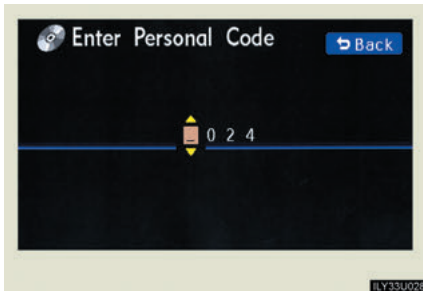

Setting a password allows use of the viewer restriction function.

Select "Parental Lock".

Enter the password and press "ENT".

The setting cannot be changed unless the password is entered.

It is necessary to initialize the password if you forget it. (→P. 221)

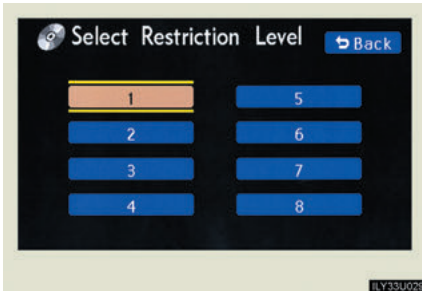

Select a restriction level (1-8), and press “ENT”. The smaller the level number, the stricter the age limit.

### Setting the display mode



Pressing **SIZE** changes the display modes sequentially as follows:  
Normal→Wide 1→Wide 2

3

Interior features

#### ■ Returning to the previous screen

Select **Back**, and press “ENT”.

#### ■ To initialize the password

Press “◀” on the remote control or unit ten times when the personal code input screen is displayed.

### ■ Language code list

Code	Language	Code	Language	Code	Language
1001	Japanese	0125	Aymara	0601	Persian
0514	English	0126	Azerbaijani	0609	Finnish
0618	French	0201	Bashkir	0610	Fiji
0405	German	0205	Byelorussian	0615	Faroese
0920	Italian	0207	Bulgarian	0625	Frisian
0519	Spanish	0208	Bihari	0701	Irish
2608	Chinese	0209	Bislama	0704	Scots-Gaelic
1412	Dutch	0214	Bengali	0712	Galician
1620	Portuguese	0215	Tibetan	0714	Guarani
1922	Swedish	0218	Breton	0721	Gujarati
1821	Russian	0301	Catalan	0801	Hausa
1115	Korean	0315	Corsican	0809	Hindi
0512	Greek	0319	Czech	0818	Croatian
0101	Afar	0325	Welsh	0821	Hungarian
0102	Abkhazian	0401	Danish	0825	Armenian
0106	Afrikaans	0426	Bhutani	0901	Interlingua
0113	Amharic	0515	Esperanto	0905	Interlingue
0118	Arabic	0520	Estonian	0911	Inupiak
0119	Assamese	0521	Basque	0914	Indonesian

Code	Language	Code	Language	Code	Language
0919	Icelandic	1307	Malagasy	1612	Polish
0923	Hebrew	1309	Maori	1619	Pashto, Pushto
1009	Yiddish	1311	Macedonian	1721	Quechua
1023	Javanese	1312	Malayalam	1813	Rhaeto- Romance
1101	Georgian	1314	Mongolian	1814	Kirundi
1111	Kazakh	1315	Moldavian	1815	Romanian
1112	Greenlandic	1318	Marathi	1823	Kinyarwanda
1113	Cambodian	1319	Malay	1901	Sanskrit
1114	Kannada	1320	Maltese	1904	Sindhi
1119	Kashmiri	1325	Burmese	1907	Sangho
1121	Kurdish	1401	Nauru	1908	Serbo- Croatian
1125	Kirghiz	1405	Nepali	1909	Sinhalese
1201	Latin	1415	Norwegian	1911	Slovak
1214	Lingala	1503	Occitan	1912	Slovenian
1215	Laothian	1513	(Afan) Oromo	1913	Samoa
1220	Lithuanian	1518	Oriya	1914	Shona
1222	Latvian	1601	Panjabi	1915	Somali

### 3-3. Using the rear audio system

Code	Language	Code	Language	Code	Language
1917	Albanian	2009	Tigrinya	2118	Urdu
1918	Serbian	2011	Turkmen	2126	Uzbek
1919	Siswati	2012	Tagalog	2209	Vietnamese
1920	Sesotho	2014	Setswana	2215	Volapük
1921	Sundanese	2015	Tonga	2315	Wolof
1923	Swahili	2018	Turkish	2408	Xhosa
2001	Tamil	2019	Tsonga	2515	Yoruba
2005	Telugu	2020	Tatar	2621	Zulu
2007	Tajik	2023	Twi		
2008	Thai	2111	Ukrainian		

#### ■ Adjusting the screen

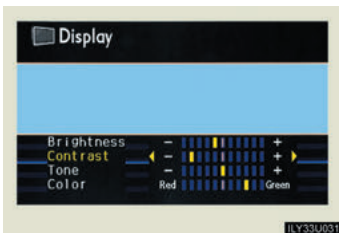

Press  .

Select the brightness, contrast, tone or color, and make adjustments. Press  or "ENT" to input it.

	"-" or Red	"+" or Green
Brightness	Darkens	Brightens
Contrast	Weakens the contrast	Strengthens the contrast
Tone	Weakens the tone	Strengthens the tone
Color	Strengthens the red color	Strengthens the green color



### 3-4. Using the interior lights

## Interior lights list

**Illuminated entry system:** The various lights automatically turn on/off according to whether the doors are locked/unlocked, whether the doors are open/closed, the ignition switch position, and the vehicle's speed.

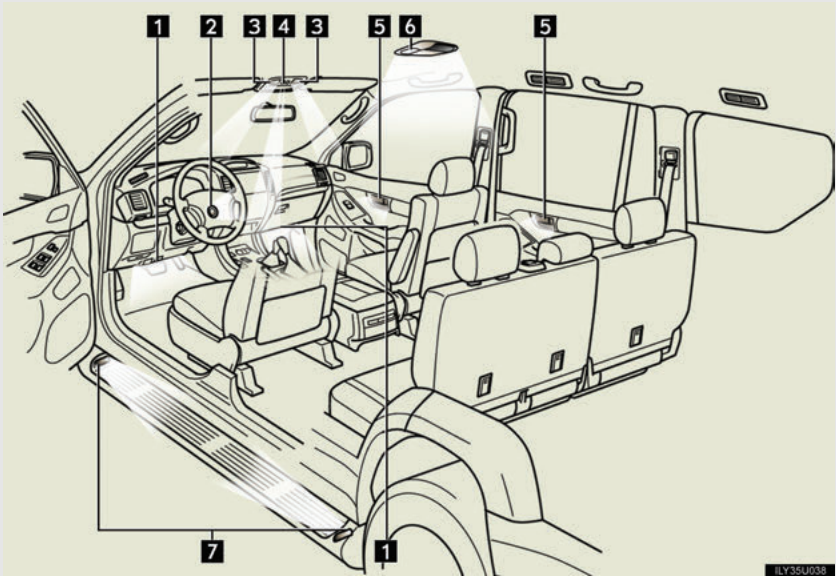

- 1** Foot light
- 2** Ignition switch light
- 3** Personal light
- 4** Center console spot lights
- 5** Inside door handle lights
- 6** Center interior light
- 7** Running board lights

When the instrument panel light control dial is turned to minimum, the foot lights will turn off. (→P. 104)

### ■ To prevent battery discharge

All of the lights will automatically turn off when the ignition key is removed and the door is left open for more than 30 minutes.

### ■ Customization

Setting (e.g. The time elapsed before lights turn off) can be changed. (→P. 400)

## Personal lights

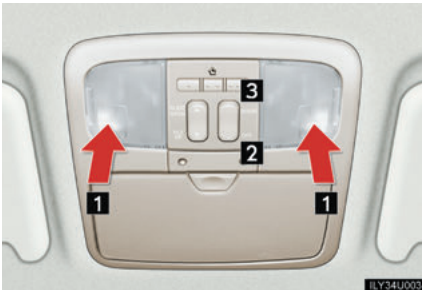

- 1 "ON"
- 2 "OFF"
- 3 "DOOR"

The lights are turned on/off by the illuminated entry system.

## Interior lights

### ► Center (without rear seat entertainment system)



- 1 "ON"
- 2 "OFF"
- 3 "DOOR"

The lights are turned on/off by the illuminated entry system.

### ► Center (with rear seat entertainment system)



- 1 "ON"
- 2 "OFF"
- 3 "DOOR"

The lights are turned on/off by the illuminated entry system.

### ► Rear



- 1 "ON"
- 2 "OFF"
- 3 "DOOR"

The light turns on when the back door is opened.

## 3-5. Using the storage features

### List of storage features



ILY35U039

- 1 Glove box
- 2 Overhead console
- 3 Cup holders
- 4 Door pocket
- 5 Console box

#### Glove box

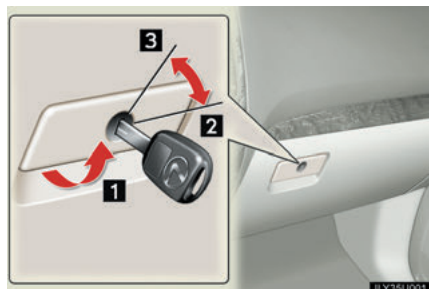

ILY35U001

- 1 Open
- 2 Lock with the key
- 3 Unlock with the key

### ■ Glove box light

The light turns on when the headlight switch is on.

### ⚠ CAUTION

#### ■ Caution while driving

Keep the glove box closed.

Injuries may result in the event of an accident or sudden braking.

### Console box

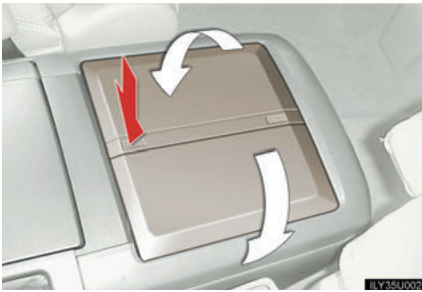

Push the center of the lid to open.

### ■ Console box light

The light turn on when the headlight switch is on.

### ⚠ CAUTION

#### ■ Caution while driving

Keep the console box closed.

Injuries may result in the event of an accident or sudden braking.

## Overhead console

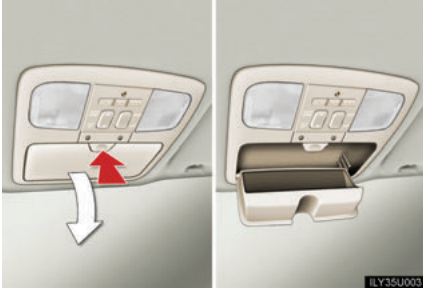

The overhead console is useful for temporarily storing sunglasses and similar small items.

### CAUTION

#### ■ Items that should not be left in the overhead console

Do not leave glasses or lighters in the console.

If the interior of the vehicle becomes hot, lighters may explode and glasses may warp or become cracked.

#### ■ Caution while driving

Do not leave the overhead console open. Items may fall out and cause injury.

#### ■ Maximum storage weight

Do not store any object heavier than 0.44 lb. (200 g) in the overhead console, as this may cause the console to open unexpectedly, leading to injury.

## Cup holders

- ▶ In front of the rear console box

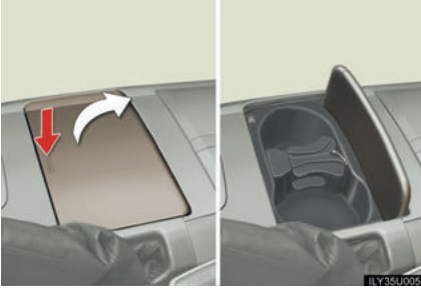

To open, press down and release the cup holder lid.

- ▶ In the rear console box



To use, open the rear console box and pull down the cup holder.

- ▶ Second seat armrest

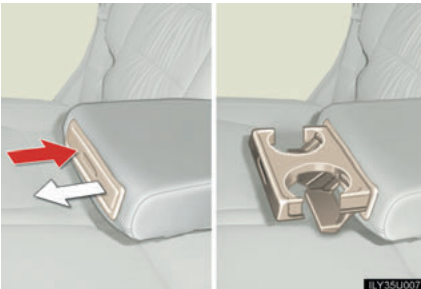

To open, press in and release the rear cup holder on the armrest.

#### ► Beside the third seat



#### **!** CAUTION

##### **■ Items unsuitable for the cup holder**

Do not place anything other than cups or aluminum cans in the cup holders. Other items may be thrown out of the holders in the event of an accident or sudden braking and cause injury. If possible, cover hot drinks to prevent burns.

##### **■ When not in use**

Keep the cup holders closed.

Injuries may result in the event of an accident or sudden braking.

#### **Door pockets**





### 3-6. Other interior features

## Sun visors

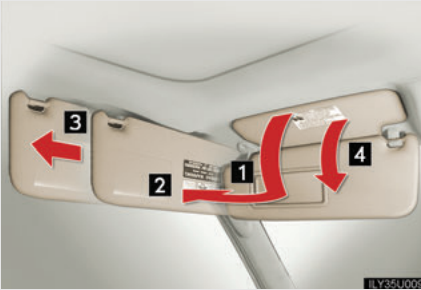

- 1 Forward position: Flip down.
- 2 Side position: Flip down, unhook, and swing to the side.
- 3 Side extender: Place in side position, then slide backwards.
- 4 The secondary sun visor may be used when the primary sun visor is in the side position.

### 3-6. Other interior features

## Vanity mirror



The light turns on when the cover is opened.

## 3-6. Other interior features

### Clock



#### ■ Adjust clock

**STEP 1** Push and hold the “MODE” button until “ILL” appear on the display.

**STEP 2** Push “MODE” button once. The time will blink.

**STEP 3**



**1** Adjust hours.

**2** Adjust minutes.

**3** Round the nearest hour.

After setting, push “MODE” button.

#### ■ The clock is displayed when

The ignition switch is in the “ACC” or “ON” position.

#### ■ When the 12 volt battery is disconnected

The time display will automatically be set to 1:00.

### 3-6. Other interior features

## Outside temperature display

The displayed temperature ranges from -22°F (-30°C) up to 122°F (50°C).



---

#### ■ Operating conditions

The ignition switch is in the "ON" position.

#### ■ When -- is displayed

The system may be malfunctioning. Take your vehicle to your Lexus dealer.

## 3-6. Other interior features

### Ashtrays

#### ► Front

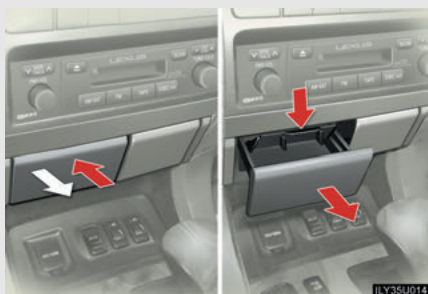

Push the lid to open.

Hold the plate down and pull the ashtray upwards to remove.

#### ► Rear

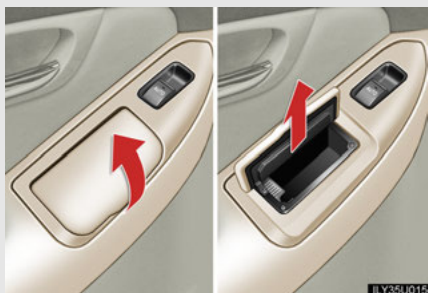

Raise the lid to open.

Hold the plate down and pull the ashtray upwards to remove.

#### ⚠ CAUTION

##### ■ When not in use

Keep the ashtray closed.

Injuries may result in the event of an accident or sudden braking.

#### ⚠ NOTICE

##### ■ To prevent fire

- Fully extinguish matches and cigarettes before putting them in the ashtray, then make sure the ashtray is fully closed.
- Do not place paper or any other type of flammable object in the ashtray.

### 3-6. Other interior features

## Cigarette lighter

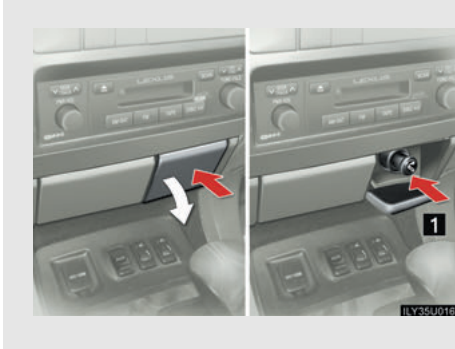

- 1 Push the cover to open, and push in the cigarette lighter.

The cigarette lighter will pop out when ready for use.

#### ■ The cigarette lighter can be used when

The ignition switch is in the "ACC" or "ON" position.

#### ⚠ CAUTION

##### ■ To avoid burns or fires

- Do not touch the metal parts of the cigarette lighter.
- Do not hold the cigarette lighter pressed in. It could overheat and cause a fire.
- Do not insert anything other than the cigarette lighter into the outlet.

### 3-6. Other interior features

## Power outlet

The power outlet can be used for a following component.

12V: Accessories that run on less than 10A.

115V AC: Audio device that use less than 100W.

#### ► 12V



#### ► 115V AC

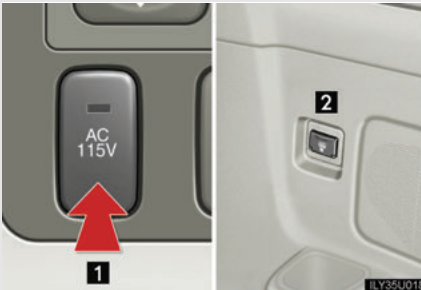

**1** To use the power outlet, push the switch.

The indicator light comes on.

**2** Power outlet socket

#### ■ The power outlet can be used when

12V: The ignition switch is in the "ACC" or "ON" position.

115V: The ignition switch is in the "ON" position.

### NOTICE

#### ■ To avoid damaging the power outlet

Close the power outlet lid when not in use.

Foreign objects or liquids that enter the power outlet may cause a short circuit.

#### ■ To prevent the fuse from being blown

12V: Do not use an accessory that uses more than 12V/10A.

115V: Do not use a 115V AC appliance that requires more than 100W.

If a 115V AC appliance that consumes more than 100W is used, the protection circuit will cut the power supply.

#### ■ To prevent battery discharge

Do not use the power outlet longer than necessary when the engine is not running.

#### ■ Appliances that may not operate properly (115V AC)

The following 115V AC appliances may not operate even if their power consumption is under 100W.

- Appliances with high initial peak wattage
- Measuring devices that process precise data.
- Other appliances that require an extremely stable power supply



### 3-6. Other interior features

## Seat heaters

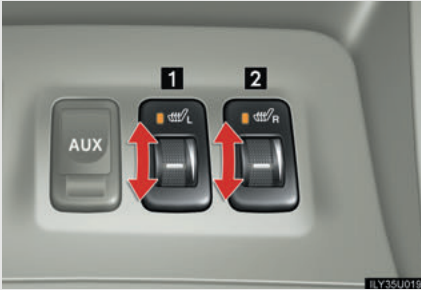

- 1 For driver's seat
  - 2 For front passenger's seat
- Turn the dial to heats the seat.  
The indicator light comes on.

#### ■ The seat heaters can be used when

The ignition switch is in the "ON" position.

#### ■ When not in use

Turn the dial until the indicator light turns off.

### ⚠ CAUTION

#### ■ Burns

- Use caution when seating the following persons in a seat with the seat heater on to avoid the possibility of burns:
  - Babies, small children, the elderly, the sick and the disabled
  - Persons with sensitive skin
  - Persons who are fatigued
  - Persons who have taken alcohol or drugs that induce sleep (sleeping drugs, cold remedies, etc.)
- Do not cover the seat with anything when using the seat heater.  
Using the seat heater with a blanket or cushion increases the temperature of the seat and may lead to overheating.

 NOTICE

■ **To prevent seat heater damage**

Do not put unevenly weighted objects on the seat and do not stick sharp objects (needles, nails, etc.) into the seat.

■ **To prevent battery discharge**

Turn the dials off when the engine is not running.

### 3-6. Other interior features

## Armrest

#### ▶ Front seat



Lower the armrest.

Raise it to the desired angle.

#### ▶ Second seat



Pull the armrest down for use.

#### NOTICE

##### ■ To prevent damage to the armrest

Do not place too much strain on the armrest.

### 3-6. Other interior features

## Floor mats

Securely place a mat that matches the size of the space on the carpet.

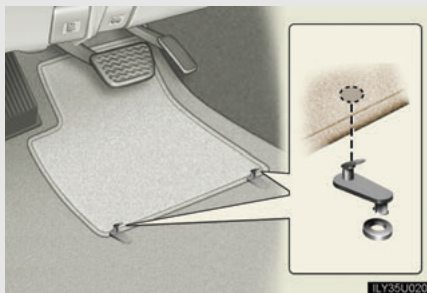

Secure the floor mat using the hooks provided.

### CAUTION

#### When inserting the floor mat

Make sure the floor mat is properly placed on the vehicle carpet. If the floor mat slips and interferes with the movement of the pedals during driving, it may cause an accident.

## 3-6. Other interior features

### Luggage compartment features

#### ■ Quarter window

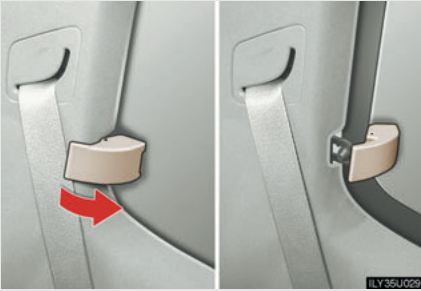

To open the quarter windows, pull the latch handle toward you and swing the window fully out.

#### ■ Cargo hooks

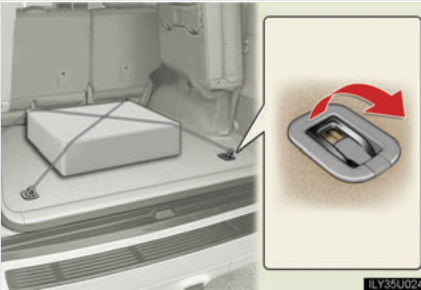

Cargo hooks are provided for securing loose items.

#### ■ Cargo net hooks

To hang the cargo net, use the cargo net hooks and cargo hooks.

The cargo net itself is not included as an original equipment.

#### ■ Storage compartment



Open the storage compartment as shown.

▶ First-aid kit storage belt

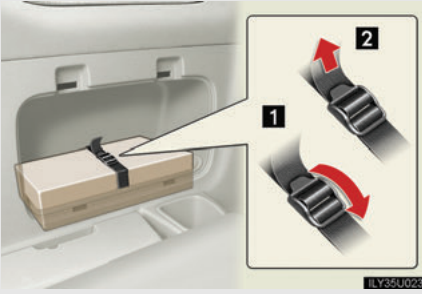

- 1 Loosen
- 2 Tighten

■ Warning reflector holder

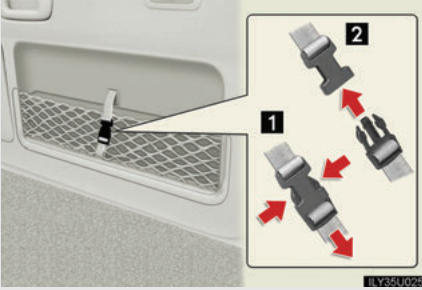

- 1 Disengage
- 2 Engage

■ Luggage cover

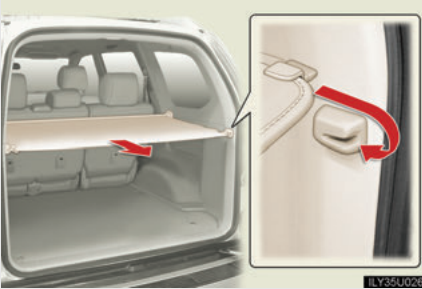

Pull out the luggage cover and hook it on the anchors.

## Removing luggage cover



Retract the cover and release both ends, then lift it out.

After removing the luggage cover, place it somewhere other than the passenger compartment.

### ■ When installing the luggage cover

Keep the "TOP" mark on the luggage cover ends upward.

### ⚠ CAUTION

#### ■ When the cargo hooks are not in use

To avoid injury, always return the cargo hooks to their positions when they are not in use.

### ⚠ NOTICE

#### ■ To prevent cargo hooks damage

Do not use the third seat anchors instead of the cargo hooks.

### 3-6. Other interior features

## Garage door opener

The garage door opener can be programmed to operate garage doors, gates, entry doors, door locks, home lighting systems, and security systems, and other devices.

The garage door opener (HomeLink<sup>®</sup> Universal Transceiver) is manufactured under license from HomeLink<sup>®</sup>.

### Programming the HomeLink<sup>®</sup> (for U.S.A. owners)

The HomeLink<sup>®</sup> compatible transceiver in your vehicle has 3 buttons which can be programmed to operate 3 different devices. Refer to the programming method below appropriate for the device.

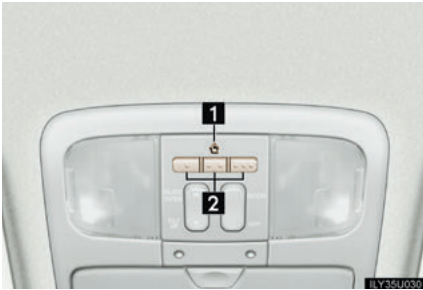

- 1 Indicator
- 2 Buttons

### ■ Programming the HomeLink<sup>®</sup>



Point the remote control for the device 1 to 3 in. (25 to 75 mm) from the HomeLink<sup>®</sup> control buttons.

Keep the indicator light on the HomeLink<sup>®</sup> in view while programming.



## STEP 2



Press and hold down one of the buttons on the HomeLink<sup>®</sup> and the button on the transmitter. When the indicator light on the HomeLink<sup>®</sup> changes from a slow to a rapid flash after 20 seconds, you can release both buttons.

## STEP 3



Test the operation of the HomeLink<sup>®</sup> by pressing the newly programmed button.

If programming a garage door opener, check to see if the garage door opens and closes. If the garage door does not operate, see if your garage transmitter is of the Rolling Code type. Press and hold the programmed HomeLink<sup>®</sup> button. The garage door has the rolling code feature if the indicator light (on the HomeLink<sup>®</sup>) flashes rapidly for 2 seconds and then remains lit. If your transmitter is the Rolling Code type, proceed to the heading "Programming a rolling code system".

STEP 4 Repeat the steps above to program another device for each of the remaining HomeLink<sup>®</sup> buttons.

### ■ Programming a Rolling Code system (for U.S.A. owners)

If your device is Rolling Code equipped, follow the steps under the heading “Programming the HomeLink<sup>®</sup>” before proceeding with the steps listed below.

**STEP 1** Locate the training button on the ceiling mounted garage door opener motor. The exact location and color of the button may vary by brand of garage door opener.

Refer to the operation manual supplied with the garage door opener for the location of the training button.

**STEP 2** Press the training button.

**STEP 3** Press and release the vehicle’s programmed HomeLink<sup>®</sup> button twice. The garage door may open.

If the garage door opens, the programming process is complete. If the door does not open, press and release the button a third time. This third press and release will complete the programming process by opening the garage door.

The ceiling mounted garage door opener motor should now recognize the HomeLink<sup>®</sup> transceiver and operate the garage door.

**STEP 4** Repeat the steps above to program another rolling code system for any of the remaining HomeLink<sup>®</sup> buttons.

### ■ Programming an entry gate (for U.S.A. owners)/Programming all devices in the Canadian market

**STEP 1** Place your transmitter 1 to 3 in. (25 to 75 mm) away from the surface of the HomeLink<sup>®</sup>.

Keep the indicator light on the HomeLink<sup>®</sup> in view while programming.

**STEP 2** Press and hold the selected HomeLink<sup>®</sup> button.

**STEP 3** Repeatedly press and release (cycle) the device’s remote control button for two seconds each until step 4 is complete.

**STEP 4** When the indicator light on the HomeLink<sup>®</sup> compatible transceiver start to flashing rapidly, release the buttons.

**STEP 5** Test the operation of the HomeLink<sup>®</sup> by pressing the newly programmed button. Check to see if the gate/device operates correctly.

**STEP 6** Repeat the steps above to program another device for each of the remaining HomeLink<sup>®</sup> buttons.

### ■ Programming other devices

To program other devices such as home security systems, home door locks or lighting, contact your authorized Lexus dealer for assistance.

### ■ Reprogramming a button

The individual HomeLink<sup>®</sup> buttons cannot be erased but can be reprogrammed. To reprogram a button, follow the “Basic programming” instructions.

## Operating the HomeLink<sup>®</sup>

Press the appropriate HomeLink<sup>®</sup> button. The HomeLink<sup>®</sup> indicator light on the HomeLink<sup>®</sup> transceiver should turn on.

The HomeLink<sup>®</sup> continues to send a signal for up to 20 seconds as long as the button is pressed.

## Erasing the entire HomeLink<sup>®</sup> memory (all three programs)



Press and hold down the 2 outside buttons for 20 seconds until the indicator light flashes.

If you sell your vehicle, be sure to erase the programs stored in the HomeLink<sup>®</sup> memory.

### ■ Before programming

- Install a new battery in the transmitter.
- The battery side of the transmitter must be pointed away from the HomeLink<sup>®</sup>.

### ■ Certification for the garage door opener

This device complies with Part 15 of the FCC Rules and with RSS-210 of the IC Rules.

Operation is subject to the following two conditions: (1) this device may not cause harmful interference, and (2) this device must accept any interference received, including interference that may cause undesired operation.

**WARNING:** This transmitter has been tested and complies with FCC and IC rules. Changes or modifications not expressly approved by the party responsible for compliance could void the user's authority to operate the device.

### CAUTION

#### ■ When programming a garage door or other remote control device

The garage door may operate, so ensure people and objects are out of danger to prevent potential harm.

#### ■ Conforming to federal safety standards

Do not use the HomeLink<sup>®</sup> Compatible Transceiver with any garage door opener or device that lacks safety stop and reverse features as required by federal safety standards.

This includes any garage door that cannot detect an obstruction object. A door or device without these features increases the risk of death or serious injury.

## 3-6. Other interior features

### Compass

The compass on the inside rear view mirror indicates the direction in which the vehicle is heading.

#### ■ Operation

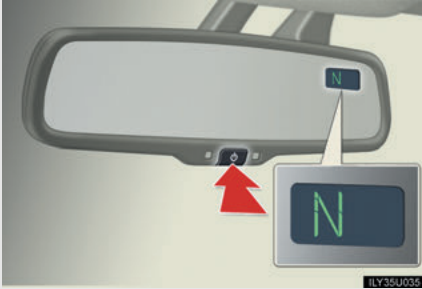

To turn the compass on or off, push the button for longer than 3 seconds.

#### ■ Displays and directions

Display	Direction
N	North
NE	Northeast
E	East
SE	Southeast
S	South
SW	Southwest
W	West
NW	Northwest

## Calibrating the compass

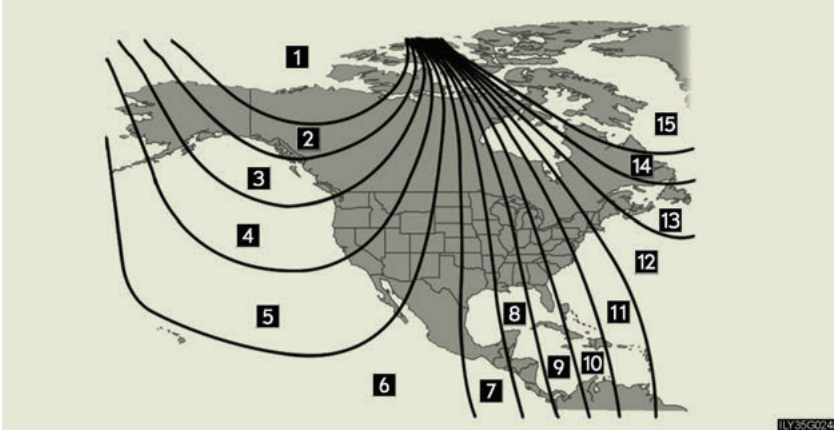

The direction display deviates from the true direction determined by the earth's magnetic field. The amount of deviation varies according to the geographic position of the vehicle.

If you cross over a map boundary shown in illustration, the compass will deviate.

To obtain higher precision or perfect calibration, refer to the following.

### ■ Deviation calibration

**STEP 1** Stop the vehicle where it is safe to drive in a circle.

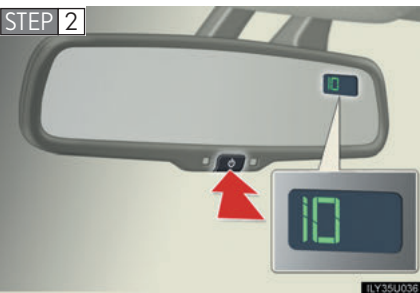

Press the button until a number (1 to 15) appears on the compass display.

**STEP 3** Press the button, and referring to the map above, select the number of the zone where you are.

**STEP 4** Wait a few seconds until the compass direction is displayed.

The calibration is complete.

### ■ Circling calibration

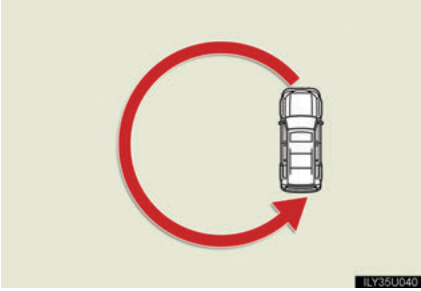

If “C” appears on the display, drive the vehicle at 5 mph (8 km/h) or less in a circle until a direction is displayed.

If there is not enough space to drive in a circle, drive around the block until the direction is displayed.

### ■ Conditions unfavorable to correct operation

The compass may not show the correct direction in the following conditions:

- The vehicle is stopped immediately after turning.
- The vehicle is on an inclined surface.
- The vehicle is in a place where the earth's magnetic field is subject to interference by artificial magnetic fields (underground car park/parking lot, under a steel tower, between buildings, roof car park/parking lot, near an intersection, near a large vehicle, etc.).
- The vehicle has become magnetized.  
(There is a magnet or metal object near the inside rear view mirror.)
- The battery has been disconnected.
- A door is open.

 CAUTION

■ **Caution while driving**

Do not adjust the display.

Be sure to adjust the display only when the vehicle is stopped.

■ **When doing the circling calibration**

Be sure to secure a wide space, and watch out for people and vehicles in the neighborhood. Do not violate any local traffic rules while performing circling calibration.

 NOTICE

■ **To avoid the compass malfunctions**

Do not place magnets or any metal objects near the inside rear view mirror.

Doing this may cause a malfunction of the compass sensor.

■ **To ensure normal operation of the compass**

● Do not perform circling calibration of the compass in a place where the earth's magnetic field is subject to interference by artificial magnetic fields.

● During calibration, do not operate electric systems (moon roof, power windows, etc.) as they may interfere with the calibration.



## 3-6. Other interior features

### Lexus Link System (if equipped)

The Lexus Link System is a communication service that uses Global Positioning System (GPS) data and cellular service to provide you with safety, security and convenience. This system is only operational in GPS and cellular coverage areas. Button operation and voice commands are used to operate the system. To operate the system, follow the voice guidance instructions. For details about service and subscription, call the Lexus Link Call Center at 1-800-25-LEXUS (1-800-255-3987) (toll-free).

#### ■ Buttons



- 1 Voice keypad button
- 2 Volume control
- 3 Phone button
- 4 "SERVICES" button
- 5 Emergency button

#### ■ Services

The Lexus Link System offers the following services.

- Airbag deployment notification (→P. 259)
- Emergency assistance (→P. 259)
- Stolen vehicle location assistance (→P. 260)
- Remote horn/lights and remote door lock/unlock (→P. 260)
- Advisor record (→P. 261)
- Personal calling (→P. 261)
- Other services (→P. 260)

Operating the Lexus Link System during a Bluetooth<sup>®</sup> phone call will terminate the Bluetooth<sup>®</sup> phone call.

## Safety information for the Lexus Link System

Important! Read this information before using the Lexus Link System.

### ■ Exposure to radio frequency signals

The Lexus Link System installed in your vehicle is a low power ratio transmitter and receiver. When the ignition switch is in the “ON” position, it receives and also sends radio frequency (RF) signals.

In August 1996, the Federal Communications Commission (FCC) adopted RF exposure guidelines with safety levels for mobile wireless phones. Those guidelines are consistent with the safety standards previously set by both U.S. and international standards bodies.

- ANIS (American National Standards Institute) C95.1 [1992]
- NCRP (National Council on Radiation Protection and Measurement) Report 86 [1986]
- ICNIRP (International Commission on Non-Ionizing Radiation Protection) [1996]

Those standards were based on comprehensive and periodic evaluations of the relevant scientific literature. Over 120 scientists, engineers, and physicians from universities, government health agencies, and industry reviewed the available body of research to develop the ANSI Standard (C95.1).

The design of the Lexus Link System complies with the FCC guidelines in addition to those standards.

## Indicator and warning lights

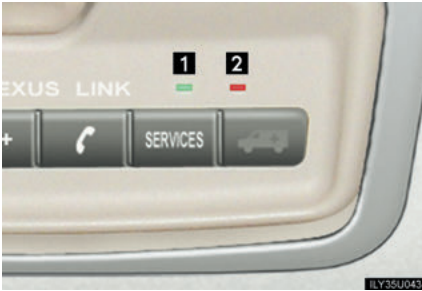

### 1 Operation indicator light

If your subscription has expired, the operation indicator light will go off.

### 2 Warning light

If the warning light (red light) comes on, have the vehicle inspected by your Lexus dealer.

## Airbag deployment notification

If an airbag deploys, an emergency call is automatically placed to the Lexus Link Call Center, and your vehicle's location is identified. The Lexus Link Advisor will attempt to contact you and assess the situation. The Advisor can quickly contact the nearest emergency services provider, describe the situation and request that assistance be sent to your location.

The Lexus Link Advisor can, if requested, connect you to an emergency services operator.

## Emergency assistance

When you press the  button, a priority call is placed to the Lexus Link Call Center with your vehicle's location. At the Call Center, the Lexus Link Advisor can determine your vehicle's location, communicate with you, and, if appropriate, contact the nearest emergency service provider.

If you have accidentally pressed the button, tell the Lexus Link Advisor that you are not experiencing an emergency.

#### Stolen vehicle location assistance

If your vehicle is stolen, call the Lexus Link Call Center at 1-800-25-LEXUS (1-800-255-3987) (toll-free) and select the option for Lexus Link.

To protect subscribers' privacy, the location of a vehicle will not be provided to anyone other than a law enforcement authority.

#### Remote horn/lights and remote door lock/unlock

The remote operations are performed by contacting the Lexus Link Call Center from the outside of the vehicle. When necessary, call the Lexus Link Call Center at 1-800-25-LEXUS (1-800-255-3987) (toll-free) and select the option for Lexus Link.

- In the case that you forget to lock the vehicle or you are locked out, the Lexus Link Call Center can send a signal to lock or unlock the vehicle remotely.
- In the case that you forget where you parked the vehicle, such as in a large parking lot, the Lexus Link Call Center can send a signal to flash the headlights and sound the horn to help you locate the vehicle.



When contacting the Lexus Link Call Center from the outside of the vehicle, you need the Lexus Link PIN (Personal Identification Number). Write the PIN down and carry it with you.

#### Other services

Press the  button in the vehicle or call the Lexus Link Call Center at 1-800-25-LEXUS (1-800-255-3987) (toll-free), and then select the option for Lexus Link. The services provided will depend on the service plan level.

## Advisor record

### ■ Recording a conversation with an advisor

Press the  button to record a conversation. To stop recording, press the  button again.

- Up to 2 minutes of recording time is available.
- Recording a new conversation deletes the previously recorded conversation.

### ■ Playing the recorded conversation

**STEP 1** Press the  or  button.

**STEP 2** Say “Advisor playback”.

Press the button again to stop the playback.

To restart the playback, press the  button, say “Advisor playback” and then select either of the following methods.

- Say “Resume” to resume the playback.
- Say “Play” to start from the beginning.

## Personal calling

The hands-free personal calling feature can be added to the Lexus Link System as an option. You can purchase a package of minutes that works best for you. As you make and receive calls, minutes are deducted from your plan. They are easily billed to a credit card that is kept on file so no separate phone bill is needed.

Personal calling universal voice recognition commands:

- **“Help”** The system will provide a list of available commands.
- **“Clear”** When you are entering digits, this command will erase the last digit entered.
- **“Cancel”** This command takes you from the current function to the “Lexus Link ready” prompt. If the last response from the system was “Lexus Link ready”, this command will exit voice mode.

Voice recognition error message:

- **“Pardon”** The system responds with this message if the system does not recognize your voice command properly. Say the command slowly again. After the third time this happens, the system will try to guess the command you are requesting. If correct, say “Yes”. If not, say “No”, and the system will prompt you with its next-best guess.
- **“Slower please”** The system responds with this message if you say a command before the system is ready to listen or if your voice command cannot be recognized because of substantial background noise. Try to wait slightly longer before speaking.

### ■ There are 5 ways to make a call.

#### ► Dialing a specific number

**STEP 1** Press the  button. When the system responds with “Lexus Link ready”, say “Dial”.

**STEP 2** When the system responds with “Phone number to dial please”, say the entire number you wish to dial without pausing.

**STEP 3** The system will repeat the number and ask “Yes or No”.

**STEP 4** Say “Yes” (or “No” to try again).

**STEP 5** The system responds with “Dialing” (your call will then be connected).

#### ► Dialing digit-by-digit (“Digit Dial”)

“Digit Dial” enables you to dial a phone number by individual digit. This is helpful when there is background noise and also improves voice recognition.

**STEP 1** Press the  button. When the system responds with “Lexus Link ready”, say “Digit dial”.

**STEP 2** When the system responds with “Digit please”, say the first digit of the number to be dialed and wait for it to be repeated back to you.

**STEP 3** Continue one digit at a time until all digits are entered.

**STEP 4** When finished, say “Dial”. The system responds with “Dialing” and your call is placed.

If you have problems storing a number using the continuous number method, you can store numbers one digit at a time using “Digit Store”. Simply follow the instructions above for “Digit Dial”, except say “Digit Store” in STEP 1 and “Store” in STEP 4.

► Dialing a phone number saved as a nametag

A nametag is a convenient way to store important or frequently called phone numbers for easy access at any time. To do this, choose a frequently-called number to store, the example below uses your home telephone number.

● How to store a nametag

**STEP 1** Press the  button. When the system responds with “Lexus Link ready”, say “Store”.

**STEP 2** When the system responds with “Phone number to store, please”, say the entire number you wish to store with no pauses. The system will repeat the number and ask “Yes or No”.

**STEP 3** Say “Yes” (or “No” to try again).

**STEP 4** When the system responds with “Nametag, please”, say “home”.

**STEP 5** When the system responds with “About to store home. Does that sound OK?”, say “Yes” (or “No” to try again).

**STEP 6** The system responds with “Storing home”.

- The system can store up to 20 nametags.

- Try to use multi-syllable nametags such as “my home”, and “the office”.

- Try to avoid similar-sounding nametags like “Tim” and “Kim”.

When using the “Dial” and “Store” commands, the system will recognize 7, 10, and 11-digit phone numbers. When dialing or storing a phone number, you can say “zero” or “oh” for 0.

### ● How to place a call using a stored nametag

**STEP 1** Press the  button. When the system responds with “Lexus Link ready”, say “Call”.

**STEP 2** When the system responds with “Nametag, please”, say the stored nametag.

**STEP 3** The system responds with “Calling [nametag]”.

### ● How to hear a list of your stored nametags

**STEP 1** Press the  button. When the system responds with “Lexus Link ready”, say “Directory”.

**STEP 2** The system will list your nametags.

#### ▶ Dialing the last number you called (“Redial”)

You can dial the last number you called by using the “Redial” feature.

**STEP 1** Press the  button. When the system responds with “Lexus Link ready”, say “Redial”.

**STEP 2** The system will respond with “Redialing [#]”.

#### ▶ Dialing a number a Lexus Link Advisor downloaded to your vehicle

**STEP 1** Press the  button. When the system responds with “Lexus Link ready”, say “Number recall”.

**STEP 2** The system will respond with “Connecting to number recall”.

### ■ Receiving a call

When someone calls you, you will hear a ring tone. Press the  button to answer the call.

If you do not answer within 30 seconds, the system will terminate the incoming call.

### ■ Ending a call

When your call is finished, press the  button to end the call.



### ■ Accessing voicemail and sending number tones to an automated phone system

You can access a voicemail system and respond to a number request from an automated phone system. When you receive the request for a number while in a call, press the  button after saying the numbers one at a time, say “Dial”.

If you do not say any commands within 5 seconds after pressing the button, or if you press the button twice, the system cannot receive the number tones you are trying to send. Press the button to try again.

### ■ How to retrieve your phone number

**STEP 1** Press the  button. When the system responds with “Lexus Link ready”, say “My number”.

**STEP 2** The system responds with “Your number is [#]”.

If the response is “Personal calling unavailable”, this means your personal calling feature is not yet active, this may take a few days from vehicle delivery. It could also mean that the personal calling service is not available in your area. Press the  button to check with an Advisor. Now that you have your number, take a moment to practice by making your first call to your home phone. Remember, the system recognizes numbers better when you say them quickly.

### ■ Verifying remaining units (minutes)

► To verify remaining minutes

**STEP 1** Press the  button. When the system responds with “Lexus Link ready”, say “Units”.

**STEP 2** When the system responds with “Verify or add”, say “Verify”.

**STEP 3** The system responds with “You have [#] units remaining”.

► To add more calling units (minutes)

**STEP 1** Press the  button. When the system responds with “Lexus Link ready”, say “Units”.

**STEP 2** When the system responds with “Verify or add”, say “Add”.

**STEP 3** The system responds with “Connecting to the Personal Calling Center”.

### ■ Security code/locking your system

The personal calling function can be locked using a 4-digit security code. While the system is locked, it is only possible to communicate with the Lexus Link Call Center.

To turn on/off the security

**STEP 1** Press the  button. When the system responds with “Lexus Link ready”, say “Security”.

**STEP 2** When the system responds with “Enter first digit of code please”, say your 4-digit code one digit at a time.

**STEP 3** After the fourth digit, the system responds with “Security (code ####) is now on/off”.

### ■ Speech recognition information

The Lexus Link speech recognition systems use speech technology that is designed to understand a wide range of speakers of American English. However, the technology may not work as well if a regional or ethnic accent is encountered. If the speech recognition system does not work properly, refer to the following.

- The system does not recognize your command properly if noise is present. Perform the following to improve voice command recognition.
  - Turn down or off the air conditioning system.
  - Slow down to reduce wind noise.
  - Close the windows and the moon roof to block outside noise.
  - Have all occupants be quiet so that the system does not recognize their conversation as a command.
- When to speak  
Say a command within 5 seconds after the system prompts you to speak.
- How to speak
  - Speak forcefully and clearly.
  - Speak calmly and naturally.
  - The driver should speak while facing forward, and the passenger should speak facing the inside rear view mirror.
  - Avoid speaking with a rising intonation. Use a flat or falling intonation.
- Tips for one-word commands
  - The system recognizes only one word at a time for personal calling. (There are some exceptions, such as “Advanced services” and “My number”.)
  - When inputting the security codes or voice-activated keypad number, you must say them one digit at a time. When inputting a phone number, the speech recognition system can recognize 7, 10, and 11-digit numbers as well as the number 911.

- Tips for entering a phone number using the “Dial” and “Store” commands
  - You do not need to say “Dial”, “Store” or “Verify” after the phone number.
  - If the phone number entered is not 7, 10, or 11 digits, use the “Dial” or “Store” command.
  - Do not pause between the digits.
  - Speech recognition does not recognize the words “Hundred” or “Thousand”. Instead, say each digit.
  - Speech recognition often works better when the digits are combined smoothly into a single phrase.
  - If the system does not recognize your command properly, use the “Digit dial” command to enter one digit at a time.
- If problems continue
  - Say each one of the syllables in the word clearly.
  - Be sure to articulate each sound in the word.
  - If the system is confusing 2 commands that are similar, be sure to pronounce the distinction.
  - Avoid clipping short words and syllables.
  - Try speaking louder to prevent background noise from drowning out your voice.
- Audible voice prompts

Some of the voice guidance instructions can be changed to Spanish. Press the



button and ask a Lexus Link Advisor.

### ■ Information on Advanced services

See the Lexus Link area of the Lexus website at [www.lexus.com/lexuslink/](http://www.lexus.com/lexuslink/) or call the Lexus Link Call Center at 1-800-25-LEXUS (1-800-255-3987)(toll free) for more information.

### ■ Certification for the Lexus Link System

FCC ID: SCWTR-423-A2

#### NOTE:

This device complies with Part 15 of the FCC Rules. Operation is subject to the following two conditions: (1) this device may not cause harmful interference and (2) this device must accept any interference received, including interference that may cause undesired operation.

### ■ Lexus Link transceiver antenna



- Before using an automatic car wash, disconnect the antenna by unscrewing it from the roof mount. When you remove the antenna, make sure the ignition is turned off.

- Use only the supplied or an approved antenna. Unauthorized antennas, modifications, or attachments could damage the Lexus Link System and may violate FCC regulations.

### ⚠ CAUTION

#### ■ FCC WARNING

Changes or modifications in construction not expressly approved by the party responsible for compliance could void the user's authority to operate the equipment.

Radio Frequency Exposure. This device is approved for Mobile Application only and, to comply with applicable FCC radio frequency exposure regulations, must be used with a distance of at least 7.9 in. (20 cm) between the antenna and the body of any person at all time during use.

#### ■ Caution regarding interference with electronic devices

Persons using medical devices such as a pacemaker should not touch or come in close contact with the antenna while the vehicle ignition is on. Otherwise, the cellular signals may cause a malfunction in the medical devices.

### NOTICE

#### ■ **To avoid damage to the system**

- Do not touch the antenna unless necessary, as this may affect transceiver quality and may cause the unit to operate at a higher power level than necessary.
- Make sure the antenna is removed before driving through an automatic car wash.

#### ■ **To ensure the Lexus Link System functions correctly**

Be sure to reattach the Lexus Link transceiver antenna.

<b>4-1. Maintenance and care</b> .....	<b>272</b>	<b>4-2. Maintenance</b> .....	<b>277</b>
Cleaning and protecting the vehicle exterior.....	272	Maintenance requirements.....	277
Cleaning and protecting the vehicle interior .....	274	General maintenance.....	279
		Emission inspection and maintenance (I/M) programs .....	282
		<b>4-3. Do-it-yourself     maintenance</b> .....	<b>283</b>
		Do-it-yourself service precautions.....	283
		Hood .....	286
		Engine compartment .....	287
		Tires.....	302
		Tire inflation pressure .....	309
		Wheels .....	313
		Air conditioning filter .....	315
		Wireless remote control battery .....	317
		Rear seat entertainment system controller.....	319
		Checking and replacing fuses.....	321
		Light bulbs.....	331

## 4-1. Maintenance and care

# Cleaning and protecting the vehicle exterior

Perform the following to protect the vehicle and maintain it in prime condition.

- Working from top to bottom, liberally apply water to the vehicle body, wheel wells and underside of the vehicle to remove any dirt and dust.  
Wash the vehicle body using a sponge or soft cloth, such as a chamois.
- For hard-to-remove marks, use car wash soap and rinse thoroughly with water.
- Wipe away any water.
- If water no longer beads on clean paint, apply wax when the vehicle body is cool.

---

### ■ Automatic car washes

- Fold the mirrors back before washing the vehicle.
- Brushes used in automatic car washes may scratch the vehicle surface and harm your vehicle's paint.

### ■ High pressure automatic car washes

Do not allow the nozzles of the car wash to come within close proximity of the windows. Before entering an automatic car wash, check that the fuel filler door is closed.

### ■ Aluminum wheels

Remove any dirt immediately by using a neutral detergent. Do not use hard brushes or abrasive cleaners. Do not use strong or harsh chemical cleaners. Use the same mild detergent and wax as used on the paint.

### ■ Bumpers and side moldings

Do not scrub with abrasive cleaners.



### ■ To prevent paint deterioration and corrosion on the body

- Wash the vehicle immediately in the following cases:
  - After driving near the sea coast
  - After driving on salted roads
  - If you see coal tar or tree sap on the paint surface
  - If you see dead insects or insect droppings on the paint
  - After driving in an area contaminated with soot, oily smoke, mine dust, iron powder or chemical substances
  - If the vehicle becomes heavily soiled in dust or mud
  - If liquids such as benzene and gasoline are spilled on the paint surface
- If the paint is chipped or scratched, have it repaired immediately.

### CAUTION

#### ■ Caution about the exhaust pipe

Exhaust gasses cause the exhaust pipe to become quite hot. When washing the vehicle, be careful not to touch the pipe until it has cooled sufficiently, as touching a hot exhaust pipe can cause burns.

### NOTICE

#### ■ To protect your vehicle's painted surfaces

Do not use organic cleaners such as benzene or gasoline.

#### ■ If the windshield washer nozzle becomes blocked

Contact your Lexus dealer. Do not try to clean it with a pin or other object, as this may damage the nozzle.

#### ■ Cleaning the exterior lights

Wash carefully. Do not use organic substances or scrub with a hard brush. This may damage the surfaces of the lights.

# Cleaning and protecting the vehicle interior

The following procedures will help protect your vehicle's interior and keep it in top condition:

### ■ Protecting the vehicle interior

Remove dirt and dust using a vacuum cleaner. Wipe dirty surfaces with a cloth dampened with lukewarm water.

### ■ Cleaning the leather areas

- Remove dirt and dust using a vacuum cleaner.
- Wipe any excess dirt and dust with a soft cloth dampened with diluted detergent.

Use a diluted water solution of approximately 5% neutral wool detergent.

- Wring out any excess water from the cloth and thoroughly wipe off all remaining traces of detergent.
- Wipe the surface with a dry, soft cloth to remove any remaining moisture. Allow the leather to dry in shaded and ventilated area.

### ■ Synthetic leather areas

- Remove loose dirt using a vacuum cleaner.
- Apply a mild soap solution to the synthetic leather using a sponge or soft cloth.
- Allow the solution to soak in for a few minutes. Remove the dirt and wipe off the solution with a clean, damp cloth.

### ■ Cleaning the inside of the rear window

Do not use glass cleaner to clean the rear window, as this may cause damage to the rear window defogger heater wires. Use a cloth dampened with lukewarm water to gently wipe the window clean. Wipe the window in strokes running parallel to the heater wires.

### ■ Caring for leather areas

Lexus recommends cleaning the interior of the vehicle at least twice a year to maintain the quality of the vehicle's interior.

### ■ Shampooing the carpets

There are several commercial foaming-type cleaners available. Use a sponge or brush to apply the foam. Rub in overlapping circles. Do not apply water. The excellent results are obtained by keeping the carpet as dry as possible.

### ■ Seat belts

Clean with mild soap and lukewarm water using a cloth or sponge. Also check the belts periodically for excessive wear, fraying or cuts.

## CAUTION

### ■ Water in the vehicle

- Be careful not to splash or spill liquid on the floor.
- Do not get any of the SRS components or wiring in the vehicle interior wet. (→P. 56)  
Electrical malfunction may cause the airbags to deploy or not function properly, resulting in death or serious injury.

### NOTICE

#### ■ **Cleaning detergents**

Do not use the following types of detergent, as they may discolor the vehicle interior or cause streaks or damage to painted surfaces.

- Non-seat portions: Organic substances such as benzene or gasoline, alkaline or acidic solutions, dye, or bleach.
- Seats: Acidic solutions, such as thinner, benzene, or alcohol.

#### ■ **Preventing damage to leather surfaces**

Observe the following precautions to avoid damage to and deterioration of leather surfaces.

- Remove any dust or dirt on leather surfaces immediately.
- Do not expose the vehicle to direct sunlight for extended periods of time. Park the vehicle in the shade, especially during summer.
- Do not place items made of vinyl, plastic, or that contain wax on the upholstery, as they may stick to the leather surface if the vehicle interior heats up significantly.

#### ■ **Water on the floor**

Do not wash the vehicle floor with water.

Vehicle systems such as the audio system may be damaged if water comes into contact with electrical components under the floor of the vehicle, and may also cause the body to rust.

#### ■ **Cleaning the inside of the rear window**

Be careful not to scratch or damage the heater wires or antenna.

# Maintenance requirements

To ensure safe and economical driving, day-to-day care and regular maintenance is essential. It is the owner's responsibility to perform regular checks. Lexus recommends the following maintenance.

### ■ General maintenance

Should be performed on a daily basis. This can be done by yourself or by a Lexus dealer.

### ■ Scheduled maintenance

Should be performed at specified intervals according to the maintenance schedule.

For details about maintenance items and schedules, refer to the "Warranty and Services Guide/Owner's Manual Supplement/Scheduled Maintenance".

### ■ Do-it-yourself maintenance

You can perform some maintenance procedures yourself. Please be aware that do-it-yourself maintenance may affect warranty coverage.

The use of Lexus service and repair manuals is recommended.

For details about warranty coverage, see the separate "Owner's Guide", "Warranty and Services Guide", "Owner's Manual Supplement" or "Warranty Booklet".

### ■ Repair and replacement

It is recommended that genuine Lexus parts be used for repair to ensure performance of each system. If non-Lexus parts are used in replacement or if a repair shop other than a Lexus dealer performs repairs, confirm the warranty coverage.

### ■ Allow inspection and repairs to be performed by a Lexus dealer

- Lexus technicians are well-trained specialists and are kept up to date with the latest service information. They are well informed about the operations of all systems on your vehicle.
- Keep a copy of the repair order. It proves that the maintenance that has been performed is under warranty coverage. If any problem should arise while your vehicle is under warranty, your Lexus dealer will promptly take care of it.

### CAUTION

#### ■ Hazardous materials

- Engine exhaust, some of its constituents, and a wide variety of automobile components contain or emit chemicals known to the State of California to cause cancer and birth defects and other reproductive harm. Work in a well ventilated area.
- Oils, fuels and fluids contained in vehicles as well as waste produced by component wear contain or emit chemicals known to the State of California to cause cancer and birth defects or other reproductive harm. Avoid exposure and wash any affected area immediately.
- Battery posts, terminals and related accessories contain lead and lead compounds which are known to cause brain damage. Wash your hands after handling. (→P. 299)
- Used engine oil contains chemicals that have been shown to cause cancer in laboratory animals. Avoid prolonged and repeated contact. Always protect your skin by washing thoroughly with soap and water.

## 4-2. Maintenance

### General maintenance

Listed below are the general maintenance items that should be performed at the intervals specified in the “Warranty and Services Guide/Owner’s Manual Supplement”. It is recommended that any problem you notice should be brought to the attention of your Lexus dealer or qualified service shop for advice.

#### Engine compartment

Items	Check points
Battery	• Maintenance-free (→P. 299)
Brake fluid	• At the correct level? (→P. 296)
Engine coolant	• At the correct level? (→P. 294)
Engine oil	• At the correct level? (→P. 289)
Exhaust system	• No fumes or strange sounds?
Power steering fluid	• At the correct level? (→P. 297)
Radiator/condenser/hoses	• Not blocked with foreign matter? (→P. 295)
Washer fluid	• At the correct level? (→P. 301)

## Vehicle interior

Items	Check points
Accelerator pedal	<ul style="list-style-type: none"> <li>• Moves smoothly (without uneven pedal effort or catching)?</li> </ul>
Automatic transmission “Park” mechanism	<ul style="list-style-type: none"> <li>• Can the vehicle be held securely on an incline with the shift lever in “P”?</li> </ul>
Brake pedal	<ul style="list-style-type: none"> <li>• Moves smoothly?</li> <li>• Does it have appropriate clearance and correct amount of free play?</li> </ul>
Brakes	<ul style="list-style-type: none"> <li>• Pulls to one side when applied?</li> <li>• Loss of brake effectiveness?</li> <li>• Spongy feeling brake pedal?</li> <li>• Pedal almost touches floor?</li> </ul>
Head restraints	<ul style="list-style-type: none"> <li>• Move smoothly and lock securely?</li> </ul>
Indicators/buzzers	<ul style="list-style-type: none"> <li>• Function properly?</li> </ul>
Lights	<ul style="list-style-type: none"> <li>• Do all the lights come on?</li> </ul>
Parking brake	<ul style="list-style-type: none"> <li>• Moves smoothly?</li> <li>• Can hold the vehicle securely on an incline?</li> </ul>
Seat belts	<ul style="list-style-type: none"> <li>• Does the seat belt system operate smoothly?</li> <li>• Are the belts undamaged?</li> </ul>
Seats	<ul style="list-style-type: none"> <li>• Do the seat controls operate properly?</li> </ul>
Steering wheel	<ul style="list-style-type: none"> <li>• Moves smoothly?</li> <li>• Has correct free play?</li> <li>• No strange noises?</li> </ul>



## Vehicle exterior

Items	Check points
Doors	<ul style="list-style-type: none"> <li>• Operate smoothly?</li> </ul>
Engine hood	<ul style="list-style-type: none"> <li>• The lock system works properly?</li> </ul>
Fluid leaks	<ul style="list-style-type: none"> <li>• Is there any leakage after parking?</li> </ul>
Tire	<ul style="list-style-type: none"> <li>• Inflation pressure is correct?</li> <li>• Tire surfaces not worn or damaged?</li> <li>• Tires rotated according to the maintenance schedule?</li> <li>• Wheel nuts are not loose?</li> </ul>

### CAUTION

#### ■ If the engine is running

Turn off the engine and ensure that there is adequate ventilation before performing maintenance checks.

### Emission inspection and maintenance (I/M) programs

Some states have vehicle emission inspection programs which include OBD (On Board Diagnostics) checks. The OBD system monitors the operation of the emission control system.

#### ■ If the malfunction indicator lamp comes on

The OBD system determines that a problem exists somewhere in the emission control system. Your vehicle may not pass the I/M test and may need to be repaired. Contact your Lexus dealer to service the vehicle.

#### ■ Your vehicle may not pass the I/M test:

- When the battery is disconnected or discharged

Readiness codes that are set during ordinary driving are erased. Also, depending on your driving habits, the readiness codes may not be completely set.

- When the fuel tank cap is loose

The malfunction indicator lamp comes on as a temporary malfunction and your vehicle may not pass the I/M test.

#### ■ When the malfunction indicator lamp goes off after several driving trips

The error code in the OBD system will not be cleared unless the vehicle is driven 40 or more times.

#### ■ If your vehicle does not pass the I/M test

Contact your Lexus dealer to prepare the vehicle for re-testing.

### 4-3. Do-it-yourself maintenance

## Do-it-yourself service precautions

If you perform maintenance yourself, be sure to follow the correct procedure given in these sections.

Items	Parts and tools
Battery condition (→P. 299)	<ul style="list-style-type: none"><li>• Warm water</li><li>• Baking soda</li><li>• Grease</li><li>• Conventional wrench (for terminal clamp bolts)</li></ul>
Brake fluid level (→P. 296)	<ul style="list-style-type: none"><li>• FMVSS No.116 DOT 3 or SAE J1703 brake fluid</li><li>• Rag or paper towel</li><li>• Funnel (used only for adding brake fluid)</li></ul>
Engine coolant level (→P. 294)	<ul style="list-style-type: none"><li>• “Toyota Super Long Life Coolant” or similar high quality ethylene glycol based non-silicate, non-amine, non-nitrite and non-borate coolant with long-life hybrid organic acid technology. For the U.S.A.: “Toyota Super Long Life Coolant” is pre-mixed with 50% coolant and 50% deionized water. For Canada: “Toyota Super Long Life Coolant” is pre-mixed with 55% coolant and 45% deionized water.</li><li>• Funnel (used only for adding coolant)</li></ul>

Items	Parts and tools
Engine oil level (→P. 289)	<ul style="list-style-type: none"> <li>• “Toyota Genuine Motor Oil” or equivalent</li> <li>• Rag or paper towel, funnel (used only for adding engine oil)</li> </ul>
Fuses (→P. 321)	<ul style="list-style-type: none"> <li>• Fuse with same amperage rating as original</li> </ul>
Power steering fluid level (→P. 297)	<ul style="list-style-type: none"> <li>• Automatic transmission fluid DEXRON® II or III</li> <li>• Rag or paper towel</li> <li>• Clean funnel</li> </ul>
Radiator and condenser (→P. 295)	—
Tire inflation pressure (→P. 309)	<ul style="list-style-type: none"> <li>• Tire pressure gauge</li> <li>• Compressed air source</li> </ul>
Washer fluid (→P. 301)	<ul style="list-style-type: none"> <li>• Water washer fluid containing anti-freeze (for winter use)</li> <li>• Funnel</li> </ul>

 **CAUTION**

The engine compartment contains many mechanisms and fluids that may move suddenly, become hot, or become electrically energized. To avoid death or serious injury.

**■ When working on the engine compartment**

- Keep hands, clothing, and tools away from the moving fan and engine drive belt.
- Be careful not to touch the engine, inverter, radiator, exhaust manifold, etc. right after driving as they may be hot. Oil and other fluids may also be hot.
- Do not leave anything that may burn easily, such as paper or rags, in the engine compartment.
- Do not smoke, cause sparks or expose an open flame to fuel or the battery. Fuel and battery fumes are flammable.
- Be extremely cautious when working on the battery. It contains poisonous and corrosive sulfuric acid.

**■ When working near the electric cooling fan or radiator grille**

Be sure the ignition switch is in "LOCK".

With the ignition switch is in the "ACC" or "ON" position, the electric cooling fan may automatically start to run if the air conditioning is on and/or the coolant temperature is high. (→P. 295)

**■ Safety glasses**

Wear safety glasses to prevent flying or falling material, fluid spray, etc. from getting in the eyes.

 **NOTICE****■ If you remove the air cleaner filter**

Driving with the air cleaner filter removed may cause excessive engine wear due to dirt in the air. Also a backfire could cause a fire in the engine compartment.

## 4-3. Do-it-yourself maintenance

### Hood

Release the lock from the inside of the vehicle to open the hood.

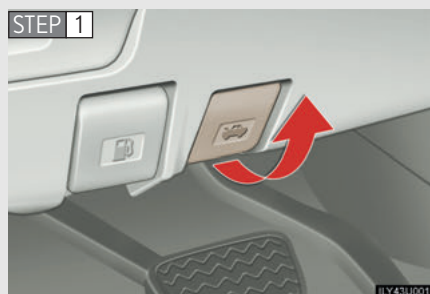

Pull the hood lock release lever.

The hood will pop up slightly.

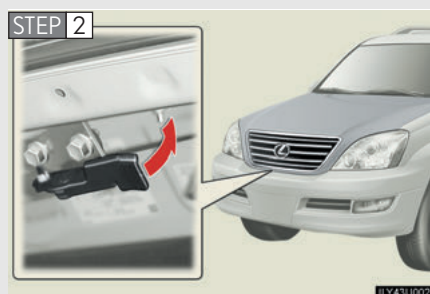

Lift the hood catch and lift the hood.

#### CAUTION

##### ■ Pre-driving check

Check that the hood is fully closed and locked.

If the hood is not locked properly it may open while the vehicle is in motion and cause an accident, which may result in death or serious injury.

## 4-3. Do-it-yourself maintenance

### Engine compartment

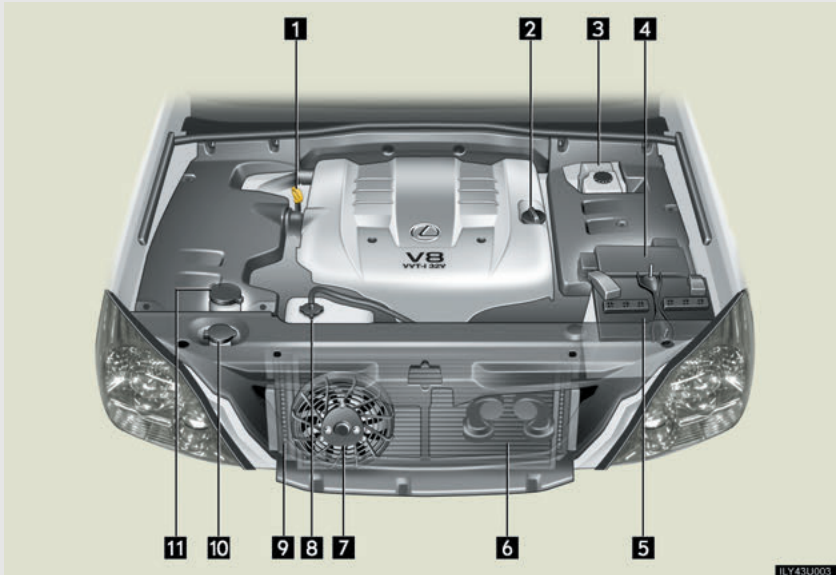

- |   |   |
|---|---|
| <b>1</b> Engine oil level dipstick<br>(→P. 289) | <b>6</b> Condenser (→P. 295)                          |
| <b>2</b> Engine oil filler cap<br>(→P. 290)     | <b>7</b> Electric cooling fan                         |
| <b>3</b> Brake fluid reservoir<br>(→P. 296)     | <b>8</b> Engine coolant reservoir<br>(→P. 294)        |
| <b>4</b> Fuse box<br>(→P. 321)                  | <b>9</b> Radiator (→P. 295)                           |
| <b>5</b> Battery<br>(→P. 299)                   | <b>10</b> Washer fluid tank (→P. 301)                 |
|   | <b>11</b> Power steering fluid reservoir<br>(→P. 297) |

## Engine compartment cover

### ■ Removing the covers

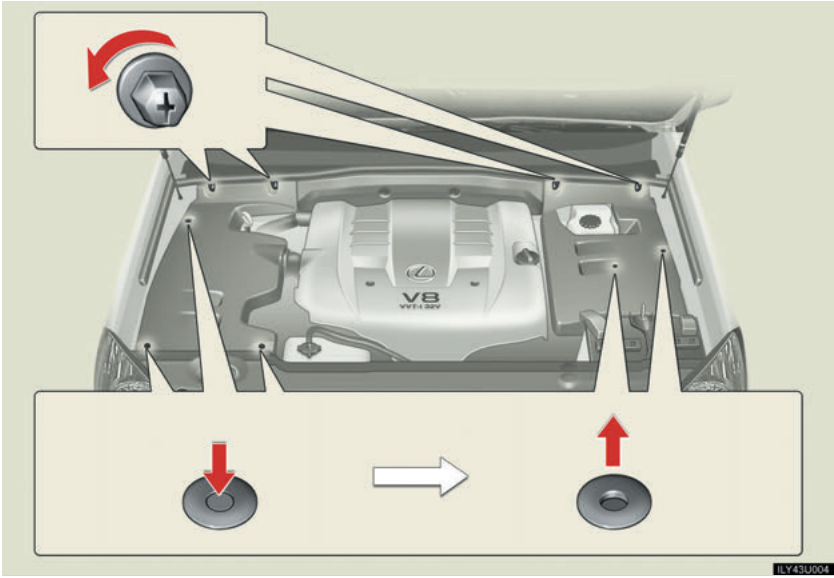

### ■ Installing the clips

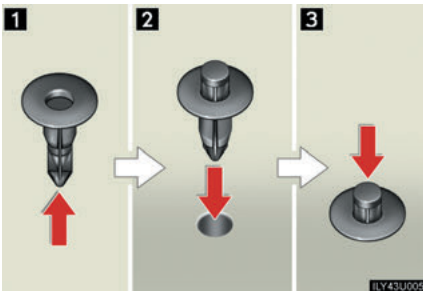

- 1 Push up center portion
- 2 Insert
- 3 Press



## Engine oil

With the engine at operating temperature and turned off, check the oil level on the dipstick.

### ■ Checking the engine oil

**STEP 1** Park the vehicle on level ground. After turning off the engine wait a few minutes for the oil to drain back into the bottom of the engine.

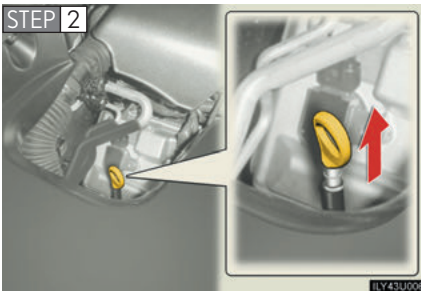

Hold a rag under the end and pull the dipstick out.

**STEP 3** Wipe the dipstick clean.

**STEP 4** Reinsert the dipstick fully.

**STEP 5** Holding a rag under the end, pull the dipstick out and check the oil level.

**STEP 6** Wipe the dipstick and reinsert it fully.

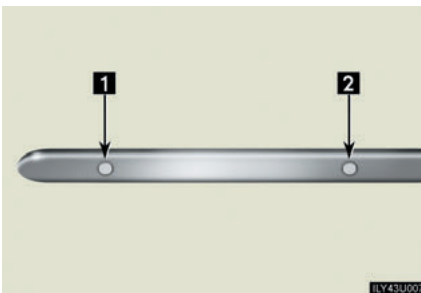

**1** Low

**2** Full

### ■ Adding engine oil



If the oil level is below or near the low level mark, add engine oil of the same type as already in the engine.

Make sure to check the oil type and prepare the items needed before adding oil.

Oil grade	ILSAC multigrade engine oil
Oil quantity (Low → Full)	1.6 qt. (1.5 L, 1.3 Imp. qt.)
Items	Clean funnel

**STEP 1** Remove the oil filler cap.

**STEP 2** Add engine oil slowly, checking the dipstick.

**STEP 3** Install the filler cap, turning it clockwise until you hear a click.

### ■ Recommended viscosity

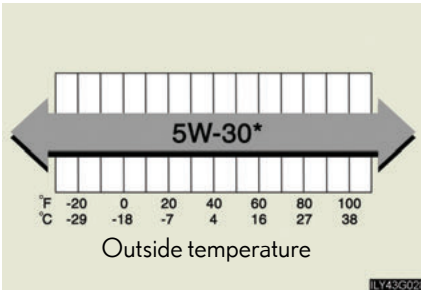

SAE 5W-30 is the best choice for good fuel economy and good starting in cold weather.

\*: If SAE 5W-30 is not available, SAE 10W-30 may be used. However, it should be replaced with SAE 5W-30 at the next oil change.

### ■ How to read oil container labels

Some oil containers are labeled with ILSAC certification marks that help you to select the proper oil.



### ■ Engine oil consumption

- The amount of engine oil consumed depends on the oil viscosity, the quality of the oil and the way the vehicle is driven.
- More oil is consumed under driving conditions such as high speeds and frequent acceleration and deceleration.
- A new engine consumes more oil.
- When judging the amount of oil consumption, keep in mind that the oil may have become diluted, making it difficult to judge the true level accurately.
- Oil consumption: Max. 1.1 qt./600 miles, 0.9 Imp.qt./600 miles (1.0 L per 1000 km). If the vehicle consumes more than this amount, contact your Lexus dealer.

### ■ Resetting the engine oil maintenance data (U.S.A. only)

Perform the following steps:

**STEP 1** Switch the display to the odometer. (→P. 103)

**STEP 2** Turn the ignition switch to the “LOCK” position.

**STEP 3** Turn the ignition switch to the “ON” position with the trip meter reset button held down.

**STEP 4** Keep pressing the knob until the “MAINT REQD” light goes off. If the light continues flashing, return to STEP 1 and try again.

 CAUTION**■ Used engine oil**

- Used engine oil contains potentially harmful contaminants which may cause skin disorders such as inflammation or skin cancer, so care should be taken to avoid prolonged and repeated contact. To remove used engine oil from your skin, wash thoroughly with soap and water.
- Dispose of used oil and filters only in a safe and acceptable manner. Do not dispose of used oil and filters in household trash, in sewers or onto the ground. Call your Lexus dealer, service station or auto parts store for information concerning recycling or disposal.
- Do not leave used engine oil within the reach of children.

 NOTICE**■ To prevent serious engine damage**

Check the oil level on regular basis.

**■ When replacing the engine oil**

- Be careful not to spill engine oil on the vehicle components.
- Avoid overfilling, or the engine could be damaged.
- Check the oil level on the dipstick every time you refill the vehicle.
- Be sure the engine oil filler cap is properly retightened.

## Engine coolant

The coolant level is satisfactory if it is between the “F” and “L” lines on the reservoir when the engine is cold.

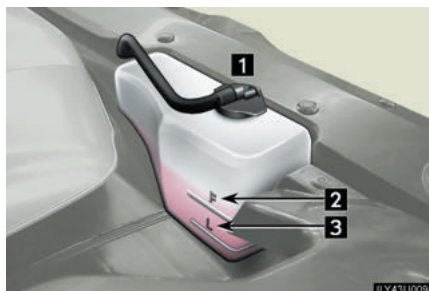

1 Reservoir cap

2 Full

3 Low

If the level is on or below the “L” line, add coolant up to the “F” line.

### ■ If the coolant level drops within a short time after replenishing

Visually check the radiator, hoses, reservoir cap, radiator cap, drain cock and water pump.

If you cannot find a leak, have your Lexus dealer pressure test the cap and check for leaks in the cooling system.

### ■ Coolant selection

Only use “Toyota Super Long Life Coolant” or similar high quality ethylene glycol based non-silicate, non-amine, non-nitrite, and non-borate coolant with long-life hybrid organic acid technology.

U.S.A.: “Toyota Super Long Life Coolant” is a mixture of 50% coolant and 50% deionized water. (Enabled: -31°F [-35°C])

Canada: “Toyota Super Long Life Coolant” is a mixture of 55% coolant and 45% deionized water. (Enabled: -44°F [-42°C])

For more details about engine coolant, contact your Lexus dealer.

 **CAUTION****■ When the engine is hot**

Do not remove the radiator cap.

The cooling system may be under pressure and may spray hot coolant if the cap is removed, causing burns or other injuries.

 **NOTICE****■ When adding the coolant**

Coolant is neither plain water nor straight antifreeze. The correct mixture of water and antifreeze must be used to provide proper lubrication, corrosion protection and cooling. Be sure to read the antifreeze or coolant label.

**■ If you spill coolant**

Be sure to wash it off with water to prevent it damage to parts or paint.

**Radiator and condenser**

Check the radiator and condenser and clear any foreign objects.

If either of the above parts are extremely dirty or you are not sure of their condition, have your vehicle checked by your Lexus dealer.

 **CAUTION****■ The radiator and condenser may be hot after driving**

To prevent burns, do not touch the radiator or condenser after driving.

## Brake fluid

### ■ Checking fluid level



The brake fluid level should be between the “MAX” and “MIN” lines on the tank.

Make sure to check the fluid type and prepare the necessary items.

### ■ Adding fluid

Fluid type	FMVSS No.116 DOT 3 or SAE J1703 brake fluid
Items	Clean funnel

### ■ Brake fluid can absorb moisture from the air

Excess moisture in the fluid can cause a dangerous loss of braking efficiency. Use only newly opened brake fluid.

## ⚠ CAUTION

### ■ When filling the reservoir

Take care because brake fluid can harm your hands or eyes and damage painted surfaces.

If fluid gets in your eyes, flush your eyes with clean water immediately.

If you still experience discomfort, see a doctor.



 NOTICE

■ **If the fluid level is low or high**

It is normal for the brake fluid level to go down slightly as the brake pads wear or when the fluid level in the accumulator is high.

If the reservoir needs frequent refilling, it may indicate a serious problem.

## Power steering fluid

■ **Fluid level**

The fluid level should be within the appropriate range.

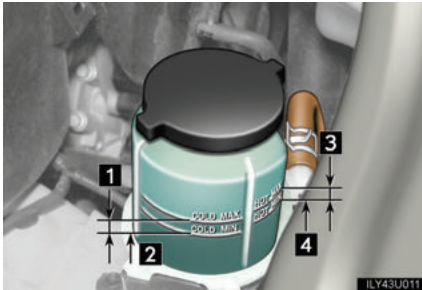

- 1 Full (when cold)
- 2 Add fluid (when cold)
- 3 Full (when hot)
- 4 Add fluid (when hot)

**Hot:** The vehicle has been driven around 50 mph (80 km/h) for 20 minutes, or slightly longer in frigid temperatures. (Fluid temperature, 140°F - 175°F [60°C - 80°C]).

**Cold:** The engine has not been run for about 5 hours. (Room temperature, 50°F - 85°F [10°C - 30°C]).

### ■ Checking the fluid level

Make sure to check the fluid type and prepare the necessary items.

Fluid type	Automatic transmission fluid DEXRON® II or III
Items	Rag or paper, clean funnel (only for adding fluid)

**STEP 1** Clean all dirt off the reservoir.

**STEP 2** Remove the cap by turning it counterclockwise.

**STEP 3** Wipe the dipstick clean.

**STEP 4** Reinstall and remove the reservoir cap again.

**STEP 5** Check the fluid level.

#### CAUTION

##### ■ When checking the reservoir

Take care, as the reservoir may be hot.

#### NOTICE

##### ■ When adding fluid

Avoid overfilling, or the power steering may be damaged.

##### ■ After replacing the reservoir cap

Check the steering box case, vane pump and hose connections for leaks or damage.

## Battery

### ■ Exterior

Make sure that the battery terminals are not corroded and that there are no loose connections, cracks, or loose clamps.

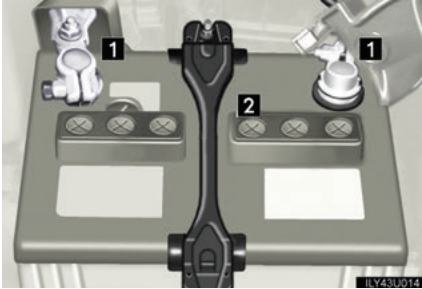

- 1 Terminals
- 2 Hold-down clamp

### ■ Checking condition

Check the battery condition by the indicator color.

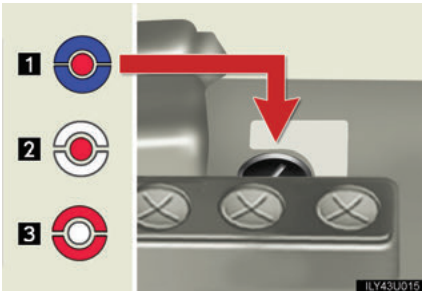

Blue: Good.

White: Charging is necessary.  
Have the vehicle inspected by your Lexus dealer.

Red: Not working properly, have the battery checked by your Lexus dealer.

### ■ Before recharging

When recharging, the battery produces hydrogen gas which is flammable and explosive. Therefore, before recharging:

- If recharging with the battery installed on the vehicle, be sure to disconnect the ground cable.
- Make sure the power switch on the charger is off when connecting and disconnecting the charger cables to the battery.

### CAUTION

#### ■ Chemicals in the battery

A battery contains poisonous and corrosive sulfuric acid and may produce hydrogen gas which is flammable and explosive. To reduce the risk of death or serious injury, take the following precautions while working on or near battery:

- Do not cause sparks by touching the battery terminals with tools.
- Do not smoke or light a match near the battery.
- Avoid contact with eyes, skin and clothes.
- Never inhale or swallow electrolyte.
- Wear protective safety glasses when working near the battery.
- Keep children away from the battery.

#### ■ Where to safely charge the battery

Always charge the battery in an open area. Do not charge the battery in a garage or closed room where there is not sufficient ventilation.

#### ■ How to recharge the battery

Only perform a slow charge (5A or less). The battery may explode if charged at a quicker rate.

#### ■ Emergency measures regarding electrolyte

- If electrolyte gets in your eyes  
Flush your eyes with clean water for at least 15 minutes and seek immediate medical attention. If possible, continue to apply water with a sponge or cloth while traveling to the nearest medical facility.
- If electrolyte gets on your skin  
Wash the affected area thoroughly. If you feel pain or a burning sensation, seek medical attention immediately.
- If electrolyte gets on your clothes  
It can soak through clothing on to your skin. Immediately take off the clothing and follow the procedure above if necessary.
- If you accidentally swallow electrolyte  
Drink a large quantity of water or milk. Follow with milk of magnesia, beaten raw egg or vegetable oil. Seek emergency medical attention immediately.

 NOTICE

■ **When recharging the battery**

Never recharge the battery while the engine is running. Also, be sure all accessories are turned off.

## Washer fluid

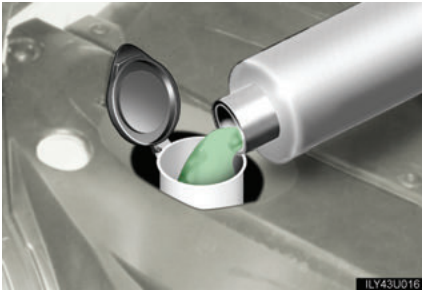

If a washer does not work, the washer tank may be empty. Add washer fluid.

 NOTICE

■ **Do not use any fluid other than washer fluid**

Do not use soapy water or engine antifreeze instead of washer fluid. Doing so may cause streaking on the vehicle's painted surfaces.

■ **Diluting washer fluid**

Dilute washer fluid with water as necessary. Refer to the freezing temperatures listed on the washer fluid tank.

## 4-3. Do-it-yourself maintenance

### Tires

Replace or rotate tires in accordance with maintenance schedules and tread wear.

#### ■ Checking tires



- 1 New tread
- 2 Tread wear indicator
- 3 Worn tread

The location of tread wear indicators is shown by the “TWI” or “Δ” marks, etc., molded on the sidewall of each tire.

Check spare tire condition and inflation pressure if not rotated.

#### ■ Tire rotation

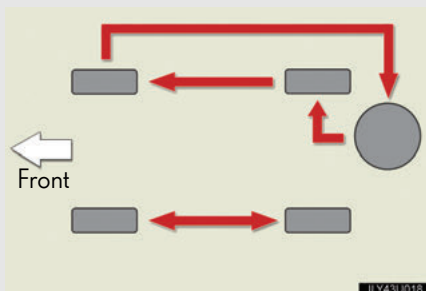

Rotate the tires in the order shown.

Lexus recommends tire rotation in accordance with the maintenance schedule to equalize tire wear and extend tire life.

#### ■ The tire pressure warning system

Your Lexus is equipped with a tire pressure warning system that uses tire pressure warning valves and transmitters to detect low tire inflation pressure before serious problems arise. (→P. 351)

## Installing tire pressure warning valves and transmitters

When replacing tires or wheels, tire pressure warning valves and transmitters must also be installed.

When new tire pressure warning valves and transmitters are installed, sensor ID codes must be registered in the tire pressure warning ECU.

## Registering and selecting ID codes

### ■ Registering ID codes

2 sets of tire pressure warning valve and transmitter ID codes can be registered. Once a second set of tires (winter tires etc.) is registered at “2nd”, you can switch between tire set settings simply by pressing the tire pressure warning select switch.

There are 2 settings:

“MAIN” position: The ID code of the tire pressure warning valve and transmitter on the tires originally installed on the vehicle is registered.

“2nd” position: The code is not registered. When you replace a new set of tires, purchase tire pressure warning valves and transmitters from your Lexus dealer and have the new ID code registered by your Lexus dealer.

### ■ Selecting ID codes

When replacing tires, make sure to select the ID code set that matches the new tire set. If the incorrect ID code is selected, the tire pressure warning system will not operate properly. After a certain period of time, the tire pressure warning light comes on after blinking for 1 minute to indicate a system malfunction.

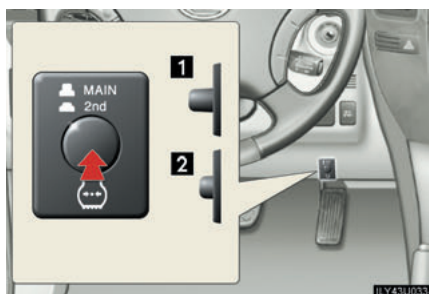

1 "MAIN"

2 "2nd"

---

### ■ When to replace your vehicle's tires

Tires should be replaced if:

- You have tire damage such as cuts, splits, cracks deep enough to expose the fabric or bulges indicating internal damage
- A tire goes flat repeatedly or cannot be properly repaired due to the size or location of a cut or other damage

If you are not sure, consult with your Lexus dealer.

### ■ Replacing tires and wheels

If the ID code is not registered, the system will not work properly. After about 1 hour, the tire pressure warning light comes on after blinking for 1 minute to indicate a system malfunction.

### ■ Tire life

Any tire over 6 years old must be checked by a qualified technician even if they have seldom or never been used or damage is not obvious.

### ■ If the tread wears down below 0.16 in. (4 mm) on snow tires

The effectiveness of snow tires is lost.



### ■ Maximum load of tire

Check that the maximum load of the replaced tire is greater than 1/2 of the Gross Axle Weight Ratings (GAWR) of either the front axle or the rear axle, whichever is greater.

As for the maximum load of the tire, see the load limit at maximum cold tire inflation pressure mentioned on the sidewall of the tire, and as for the Gross Axle Weight Ratings (GAWR), see the Certification Label. (→P. 309, 390).

### ■ Tire types

#### 1 Summer tires

Summer tires are high-speed performance tires best suited to highway driving under dry conditions. Since summer tires do not have the same traction performance as snow tires, summer tires are inadequate for driving on snow-covered or icy roads. For driving on snow-covered roads or icy roads, the use of snow tires is recommended. When installing snow tires, be sure to replace all four tires.

#### 2 All season tires

All season tires are designed to provide better traction in snow and to be adequate for driving in most winter conditions, as well as for use year round. All season tires, however, do not have adequate traction performance compared with snow tires in heavy or loose snow. Also, all season tires fall short in acceleration and handling performance compared with summer tires in highway driving.

#### 3 Snow tires

For driving on snow-covered roads or icy roads, we recommend using snow tires. If you need snow tires, select tires of the same size, construction and load capacity as the originally installed tires. Since your vehicle has radial tires as original equipment, make sure your snow tires also have radial construction. Do not install studded tires without first checking local regulations for possible restriction. Snow tires should be installed on all wheels. (→P. 146)

### ■ If you push the tire pressure reset switch accidentally

If initialization is performed, adjust the tire inflation pressure to the specified level and initialize the system again.

### ■ Routine tire inflation pressure checks

The tire pressure warning system does not replace routine tire inflation pressure checks. Make sure to check tire inflation pressure as part of your routine of daily vehicle checks.

### ■ If the tire pressure select switch is set to the wrong tire setting

The system will not work properly. After about 1 hour, the tire pressure warning light comes on after blinking for 1 minute to indicate a system malfunction.

### ■ Tire pressure warning system certification

- ▶ For vehicles sold in the U.S.A.

#### NOTE:

This device complies with Part 15 of the FCC Rules. Operation is subject to the following two conditions: (1) this device may not cause harmful interference, and (2) this device must accept any interference received, including interference that may cause undesired operation.

#### NOTICE:

This equipment has been tested and found to comply with the limits for a Class B digital device, pursuant to Part 15 of the FCC Rules. These limits are designed to provide reasonable protection against harmful interference in a residential installation. This equipment generates, uses and can radiate radio frequency energy and, if not installed and used in accordance with the instructions, may cause harmful interference to radio communications. However, there is no guarantee that interference will not occur in a particular installation. If this equipment does cause harmful interference to radio or television reception, which can be determined by turning the equipment off and on, the user is encouraged to try to correct the interference by one or more of the following measures:

- Reorient or relocate the receiving antenna.
- Increase the separation between the equipment and receiver.
- Connect the equipment into an outlet on a circuit different from that to which the receiver is connected.
- Consult the dealer or an experienced radio/TV technician for help.

#### FCC WARNING:

Changes or modifications not expressly approved by the party responsible for compliance could void the user's authority to operate the equipment.

- ▶ For vehicles sold in Canada

#### NOTE:

Operation is subject to the following two conditions: (1) this device may not cause interference, and (2) this device must accept any interference, including interference that may cause undesired operation of the device.

### CAUTION

#### ■ When inspecting or replacing tires

Observe the following precautions to prevent accidents. Failure to do so may cause damage to parts of the drive train, as well as dangerous handling characteristics, which may lead to fatal or injury accidents.

- Do not mix tires of different makes, models, tread patterns or tread wear.
- Do not use tire sizes other than those recommended by Lexus.
- Do not mix radial, bias-belted, or bias-ply tires.
- Do not mix summer, all season and winter tires.

### NOTICE

#### ■ Repairing or replacing tires, wheels and tire pressure warning valves and transmitters

- When removing or fitting the wheels, tires or the tire pressure warning valve and transmitter, contact your Lexus dealer as the tire pressure warning valve and transmitter may be damaged if not handled correctly.
- When replacing tires, make sure also to replace the tire pressure warning valve and transmitter grommets.

#### ■ Do not use puncture sealant sprays to repair flats

Puncture sealant sprays may damage tire pressure warning valves and transmitters.

#### ■ Driving on rough roads

Take particular care when driving on roads with loose surfaces or potholes. These conditions may cause losses in tire inflation pressure, reducing the cushioning ability of the tires. In addition driving on rough roads may cause damage to the tires themselves, as well as the vehicle's wheels and body.

#### ■ If tire inflation pressures become low while driving

Do not continue driving, or your tires and/or wheels may be ruined.

## 4-3. Do-it-yourself maintenance

### Tire inflation pressure

#### Tire inflation pressure

The recommended cold tire inflation pressure and tire size is displayed on the tire and loading information label. (→P. 385)



TIRE AND LOADING INFORMATION			INFORMATION SUR LES PNEUS ET LE CHARGEMENT		
SEATING CAPACITY: TOTAL X FRONT X REAR X The combined weight of occupants and cargo should never exceed XXX kg or XXX lb.			NOMBRE DE PLACES ASSISES: TOTAL X AVANT X ARRIERE X Le poids total des occupants et du chargement ne doit jamais être supérieur à XXX kg ou XXX lb.		
TIRE	SIZE	COLD TIRE PRESSURE	PNEUS	DIMENSION	PRESSION DE GONFLAGE À FROID
FRONT	P1000X00R00X	XXX0Pa,XXPSI	AVANT	P1000X00R00X	XXX0Pa,XXPSI
REAR	P1000X00R00X	XXX0Pa,XXPSI	ARRIÈRE	P1000X00R00X	XXX0Pa,XXPSI
SPARE	P1000X00R00X	XXX0Pa,XXPSI	SECOURS	P1000X00R00X	XXX0Pa,XXPSI
SEE OWNER'S MANUAL FOR ADDITIONAL INFORMATION			POUR DE PLUS AMPLES INFORMATIONS, VOIR LE MANUEL DU PROPRIÉTAIRE		

ILY43U012

### ■ Inspection and adjustment procedure



1 Tire valve

2 Tire pressure gauge

**STEP 1** Remove the tire valve cap.

**STEP 2** Press the tip of the tire pressure gauge onto the tire valve.

**STEP 3** Read the pressure using the graduations of the gauge.

**STEP 4** If the tire inflation pressure is not within the recommended levels, adjust tire pressure.

If you add too much air, press the center of the valve to lower.

**STEP 5** After completing the tire inflation pressure measurement and adjustment, apply soapy water to the valve and check for leakage.

**STEP 6** Reinstall the tire valve cap.

### ■ Tire inflation pressure check interval

You should check tire inflation pressure every 2 weeks, or at least once a month. Do not forget to check the spare.

**■ Effects of incorrect tire inflation pressure**

Driving with incorrect tire inflation pressure may result in the following:

- Reduced fuel efficiency
- Reduced driving comfort and tire life
- Reduced safety
- Damage to the drive train

If a tire needs frequent refilling, have it checked by your Lexus dealer.

**■ Instructions for checking tire inflation pressure**

When checking tire inflation pressure, observe the following:

- Check only when the tires are cold.  
If your vehicle has been parked for at least 3 hours and has not been driven for more than 1 mile or 1.5 km, you will get an accurate cold tire inflation pressure reading.
- Always use a tire pressure gauge.  
The appearance of the tire can be misleading. In addition, tire inflation pressures that are even just a few pounds off can degrade ride and handling.
- Do not bleed or reduce tire inflation pressure after driving. It is normal for the tire inflation pressure to be higher after driving.
- Never exceed the vehicle capacity weight.  
Passengers and luggage weight should be placed so that the vehicle is balanced.

### CAUTION

#### ■ Proper inflation is critical to save tire performance

Keep your tires properly inflated. Otherwise, the following conditions may occur and result in an accident causing death or serious injury.

- Excessive wear
- Uneven wear
- Poor handling
- Possibility of blowouts resulting from overheated tires
- Poor sealing of the tire bead
- Wheel deformation and/or tire separation
- A greater possibility of tire damage from road hazards

### NOTICE

#### ■ When inspecting and adjusting tire inflation pressure

Be sure to reinstall the tire valve caps.

Without the valve caps, dirt or moisture could get into the valve and cause air leakage, which could result in an accident. If the caps have been lost, replace them as soon as possible.



# Wheels

If a wheel is bent, cracked or heavily corroded, it should be replaced. Otherwise, the tire may separate from the wheel or cause loss of handling control.

### ■ Wheel selection

When replacing wheels, care should be taken to ensure that they are equivalent to those removed in load capacity, diameter, rim width, and offset.

Replacement wheels are available at your Lexus dealer.

Lexus does not recommend using:

- Wheels of different sizes or types
- Used wheels
- Bent wheels that have been straightened
- Lexus wheels with after market chrome plating

### ■ Aluminum wheel precautions

- Use only Lexus wheel nuts and wrenches designed for use with your aluminum wheels.
- When rotating, repairing or changing your tires, check that the wheel nuts are still tight after driving 1000 miles (1600 km).
- Be careful not to damage the aluminum wheels when using tire chains.
- Use only Lexus genuine balance weights or equivalent and a plastic or rubber hammer when balancing your wheels.

### ■ When replacing wheels

The wheels of your Lexus are equipped with tire pressure warning valves and transmitters that allow the tire pressure warning system to provide advanced warning in the event of a loss in tire inflation pressure. Whenever wheels are replaced, the tire pressure warning valves and transmitters must be switched over from the old wheels. (→P. 303)

### CAUTION

#### ■ When replacing wheels

- Do not use wheels that are a different size from those recommended in the Owner's Manual, as this may result in loss of handling control.
- Never use an inner tube in a leaking wheel which is designed for a tubeless tire. Doing so may result in an accident, causing death or serious injury.

### NOTICE

#### ■ Replacing tire pressure warning valves and transmitters

- Because tire repair or replacement may affect the tire pressure warning valves and transmitters, make sure to have tires serviced by your Lexus dealer. In addition, make sure to purchase your tire pressure warning valves and transmitters at your Lexus dealer.
- Ensure that only genuine Lexus wheels are used on your vehicle. Tire pressure warning valves and transmitters may not work properly with non-genuine wheels.

## 4-3. Do-it-yourself maintenance

### Air conditioning filter

The air conditioning filter must be changed regularly to maintain air conditioning efficiency.

**STEP 1** Turn the ignition switch to the “LOCK” position.

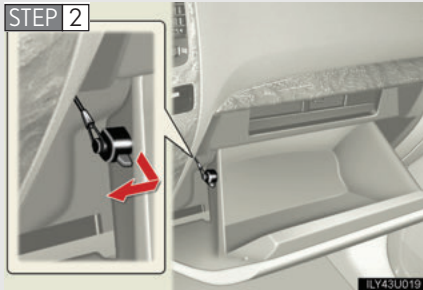

Open the glove box and unhook the clip.

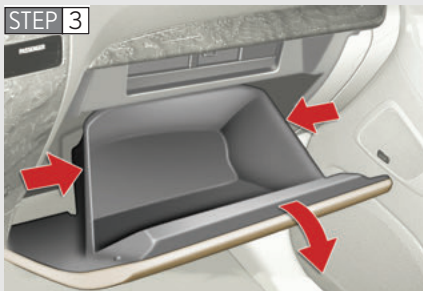

Push in each side of the glove box to disconnect the claws.



Remove the filter case.

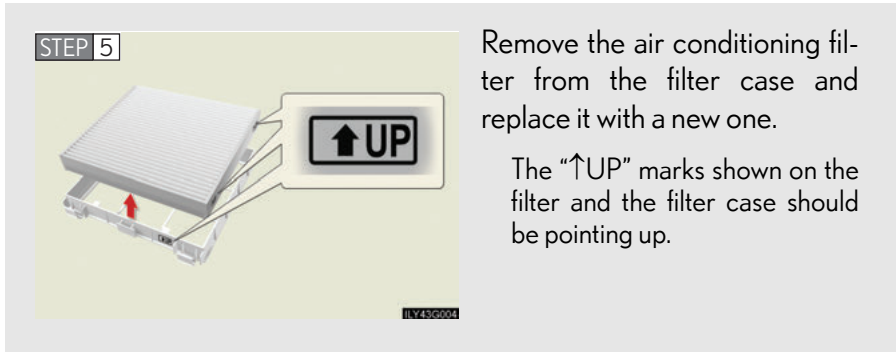

### ■ Changing interval

Inspect and replace the air conditioning filter according to the maintenance schedule. In dusty areas or areas with heavy traffic flow, early replacement may be required. (For scheduled maintenance information, refer to the “Warranty and Services Guide/Owner’s Manual Supplement/Scheduled Maintenance”.)

### ■ If air flow from the vents decreases dramatically

The filter may be clogged. Check the filter and replace if necessary.

### NOTICE

#### ■ When using the air conditioning system

Make sure that a filter is always installed.

Using the air conditioning system without a filter may cause damage to the system.

## 4-3. Do-it-yourself maintenance

# Wireless remote control battery

Replace the battery with a new one if it is discharged.

■ You will need the following items:

- Small Phillips-head screwdriver
- Lithium battery (CR1616)

■ Replacing the battery

STEP 1

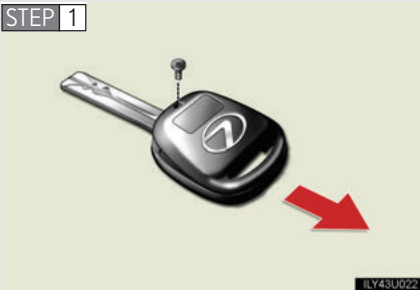

Remove the screw and cover.

Push the cover in the arrow direction.

STEP 2



Remove the module.

STEP 3



Remove the 2 screws to take out the lid.

Insert a new battery with the “+” terminal facing up.

### ■ If the battery is discharged

The following symptoms may occur.

- The wireless remote control will not function properly.
- The operational range is reduced.

### ■ Use a CR1616 lithium battery

- Batteries can be purchased at your Lexus dealer, jewelers, or camera stores.
- Replace only with the same or equivalent type recommended by a Lexus dealer.
- Dispose of used batteries according to the local laws.

### CAUTION

#### ■ Removed battery and other parts

Keep away from children.

These parts are small and if swallowed by a child they can cause choking.

### NOTICE

#### ■ For normal operation after replacing the battery

Observe the following precautions to prevent accidents.

- Always work with dry hands.  
Moisture may cause the battery to rust.
- Do not touch or move any other components inside the electronic key.
- Do not bend the battery terminals.

## 4-3. Do-it-yourself maintenance

# Rear seat entertainment system controller

Replace the batteries if they are discharged.

### ■ Necessary items

3 AA batteries

### ■ Replacing the battery

STEP 1

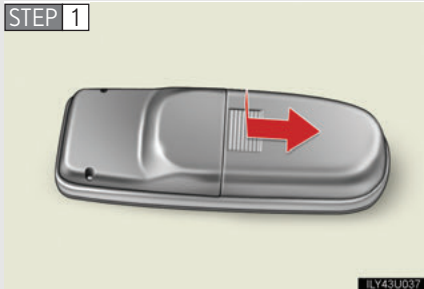

Remove the cover.

STEP 2

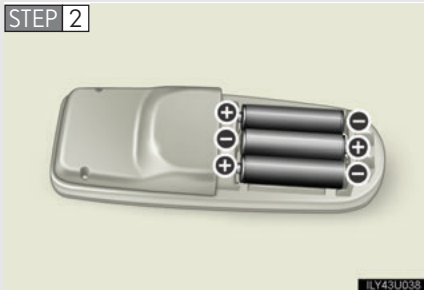

Remove the depleted batteries and install the new batteries.

### ■ If the batteries are discharged

The following symptoms may occur.

- The rear seat entertainment system control will not function properly.
- The operational range is reduced.

### ■ Use 3 AA batteries

- Batteries can be purchased at your Lexus dealer, jewelers, or camera stores.
- Replace only with the same or equivalent type recommended by a Lexus dealer.
- Dispose of used batteries according to the local laws.

### CAUTION

#### ■ **Removed battery and other parts**

Keep away from children.

These parts are small and if swallowed by a child they can cause choking.

### NOTICE

#### ■ **For normal operation after replacing the battery**

Observe the following precautions to prevent accidents.

- Always work with dry hands.  
Moisture may cause the battery to rust.
- Do not touch or move any other components inside the remote control.
- Do not bend the battery terminals.



## 4-3. Do-it-yourself maintenance

### Checking and replacing fuses

If any of the electrical components do not operate, a fuse may have blown. If this happens, check and replace the fuses as necessary.

**STEP 1** Turn the ignition switch to the “LOCK” position.

**STEP 2** Open the fuse box cover.

▶ Engine compartment

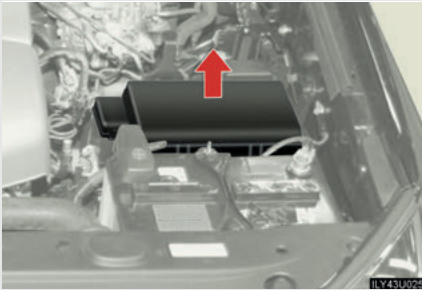

Push the tabs in and lift the lid off.

▶ Driver's side instrument panel



Remove the lid.

**STEP 3** After a system failure, see “Fuse layout and amperage ratings” (→P. 323) for details about which fuse to check.

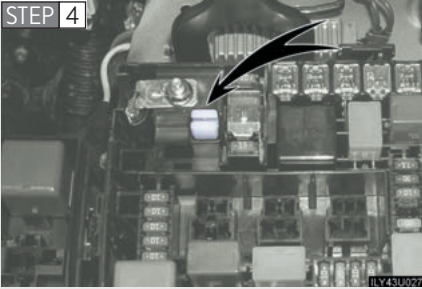

Remove the fuse with the pull-out tool.

**STEP 5** Check if the fuse has blown.

► Type A

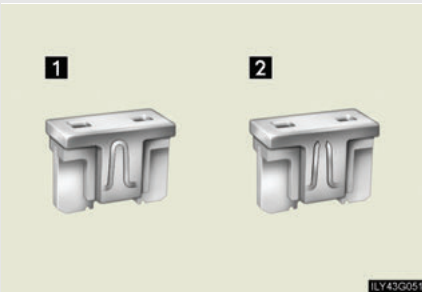

**1** Normal fuse

**2** Blown fuse

Replace it with one of an appropriate amperage rating. The amperage rating can be found on the fuse box lid.

► Type B

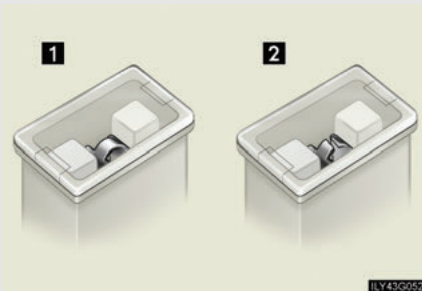

**1** Normal fuse

**2** Blown fuse

Replace it with one of an appropriate amperage rating. The amperage rating can be found on the fuse box lid.

## Fuse layout and amperage ratings

### ■ Engine compartment

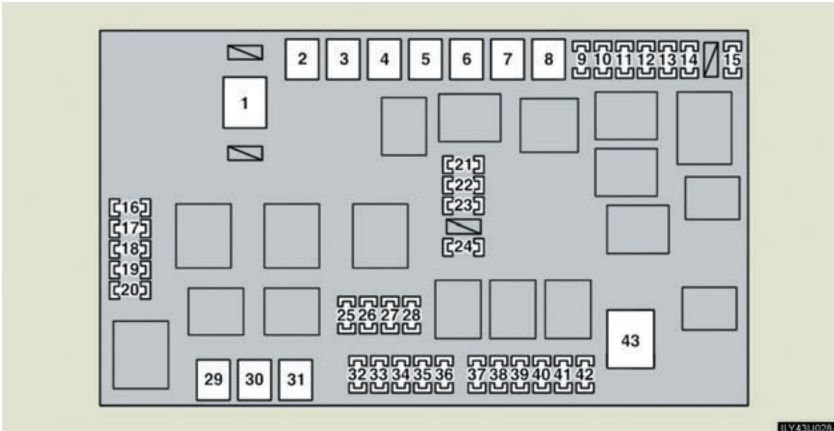

Fuse		Ampere	Circuit
1	ALT	140	Charging system, AM1, HEATER, CDS FAN, FR FOG, DEFOG, AIR SUS, AC INV, SEAT HEATER, OBD, STOP, J/B, RR AC, MIR HEATER, BATT CHG, TOWING BRK, TOWING
2	HEATER	50	Air conditioning system
3	AIR SUS	50	Rear height control air suspension
4	AM1	50	ACC, CIG, IG1, FR WIP-WSH, RR WIP, RR WSH, DIFF, ECU-IG, TEMS, STA
5	TOWING BRK	30	Trailer brake controller
6	J/B	50	P FR P/W, P RR P/W, D RR P/W, D P/SEAT, P P/SEAT, TAIL, PANEL, POWER OR TI&TE
7	BATT CHG	30	Trailer sub battery

### 4-3. Do-it-yourself maintenance

Fuse		Ampere	Circuit
8	TOWING	40	Trailer lights
9	CDS FAN	20	Electric cooling fan
10	RR A/C	30	Rear air conditioning system
11	MIR HEATER	10	Outside rear view mirror defogger
12	STOP	10	Stop lights, high mounted stoplight, shift lock control system, vehicle stability control system, electronic modulated suspension, rear height control air suspension, multiport fuel injection system/sequential multiport fuel injection system
13	AC INV	15	Power outlet (115V AC)
14	FR FOG	15	Front fog lights
15	OBD	7.5	On-board diagnosis system
16	HEAD (LO RH)	10	Right hand headlight (low beam)
17	HEAD (LO LH)	10	Left hand headlight (low beam)
18	HEAD (HI RH)	10	Right hand headlight (high beam)
19	HEAD (HI LH)	10	Left hand headlight (high beam)
20	EFI NO.2	10	Multiport fuel injection system/sequential multiport fuel injection system
21	HEATER No.2	7.5	Air conditioning system
22	DEFOG	30	Rear window defogger
23	AIRSUS NO.2	10	Rear height control air suspension
24	SEAT HEATER	20	Seat heaters

Fuse		Ampere	Circuit
25	DOME	10	Ignition switch light, interior lights, personal lights, foot lights, running board lights, door courtesy lights, inside door handle lights, trip information display
26	RADIO NO.1	20	Audio system, navigation system
27	ECU-B	10	Multiplex communication system, vehicle stability control system, wireless remote control system, inside rear view mirror, air conditioning system, electronic modulated suspension, driving position memory system, power windows, moon roof, rear view monitor system
28	ECU-B NO.2	10	Theft deterrent system
29	ABS MTR	40	Anti-lock brake system, vehicle stability control system, active traction control system, brake assist system
30	AM2	30	Starting system, IGN, SRS, GAUGE, ST2
31	ABS SOL	30	Anti-lock brake system, vehicle stability control system, active traction control system, brake assist system
32	ALT-S	7.5	Charging system
33	MAYDAY	7.5	Lexus Link System
34	HORN	10	Horns

### 4-3. Do-it-yourself maintenance

Fuse		Ampere	Circuit
35	A/F HEATER	15	A/F sensor
36	TRN-HAZ	15	Turn signal lights
37	ETCS	10	Electronic throttle control system
38	EFI	20	Multiport fuel injection system/ sequential multiport fuel injection system
39	D FR P/W	20	Power window
40	DR/LCK	25	Power door lock
41	TOWING	30	Towing converter
42	RADIO NO.2	30	Audio system, navigation system
43	A/PUMP	50	Multiport fuel injection system/ sequential multiport fuel injection system

## ■ Driver's side instrument panel

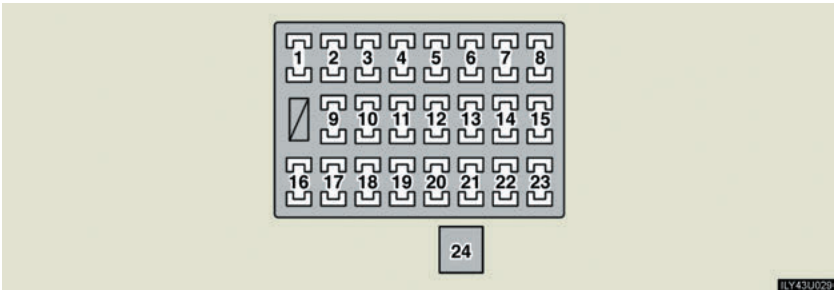

Fuse		Ampere	Circuit
1	IGN	10	Multiport fuel injection system/ sequential multiport fuel injection system, vehicle stability control sys- tem
2	SRS	10	SRS airbag system, front passenger occupant classification system
3	GAUGE	7.5	Gauges and meters
4	ST2	7.5	Multiport fuel injection system/ sequential multiport fuel injection system
5	FR WIP-WSH	30	Windshield wipers, windshield washer
6	TEMS	20	Electronic modulated suspension
7	DIFF	20	Four-wheel drive system
8	RR WIP	15	Rear window wiper
9	D P/SEAT	30	Driver's power seat
10	P P/SEAT	30	Front passenger's power seat
11	PWR OUTLLET	15	Power outlet (12V DC)

### 4-3. Do-it-yourself maintenance

Fuse		Ampere	Circuit
12	IG1NO.2	10	Rear air conditioning system, inside rear view mirror, kinetic dynamic suspension system
13	RR WSH	15	Rear window washer
14	ECU-IG	10	Shift lock control system, power windows, outside rear view mirror defogger, anti-lock brake system, active traction control system, vehicle stability control system, air conditioning system, navigation system, power windows, moon roof, tilt and telescopic steering, trip information display, driving position memory system, rear view monitor system, tire pressure warning system
15	IG1	10	Air conditioning system, back-up lights, rear window defogger, seat heaters, vehicle stability control system
16	STA	7.5	Multiport fuel injection system/ sequential multiport fuel injection system
17	P FR P/W	20	Front passenger's power window
18	P RR P/W	20	Rear right side power window
19	D RR P/W	20	Rear left side power window
20	PANEL	10	Instrument panel lights
21	TAIL	10	Parking lights, tail lights, license plate lights, front fog lights



Fuse		Ampere	Circuit
22	ACC	7.5	Shift lock control system, power outlet, outside rear view mirror, audio system, navigation system, power rear view mirrors, trip information display, rear view monitor system
23	CIG	10	Cigarette lighter
24	POWER OR TI&TE	30	Power windows, moon roof, tilt and telescopic steering

#### ■ After a fuse is replaced

- If the lights do not turn on even after the fuse has been replaced, a bulb may need replacement. (→P. 331)
- If the replaced fuse blows again, have the vehicle inspected by your Lexus dealer.

#### ■ If there is an overload in the circuits

The fuses are designed to blow before the entire wiring harness is damaged.

 **CAUTION**

■ **To prevent system breakdowns and vehicle fire**

- Observe the following precautions.  
Failing to do so may cause damage, and possibly a fire or injury.
- Never use a fuse of a higher amperage rating than indicated, or use any other object in place of a fuse.
- Always use a genuine Lexus fuse or equivalent.  
Never replace a fuse with a wire, even as a temporary fix.  
This can cause extensive damage or even fire.
- Do not modify fuses or the fuse box.

 **NOTICE**

■ **Before replacing fuses**

Have the cause of electrical overload determined and repaired by your Lexus dealer.

## 4-3. Do-it-yourself maintenance

# Light bulbs

You may replace the following bulbs yourself. For more information about replacing other light bulbs, contact your Lexus dealer.

### ■ Prepare a replacement light bulb.

Check the wattage of the light bulb being replaced. (→P. 386)

### ■ Remove the engine compartment cover if necessary.

→P. 288

### ■ Front bulb locations



### ■ Rear bulb locations

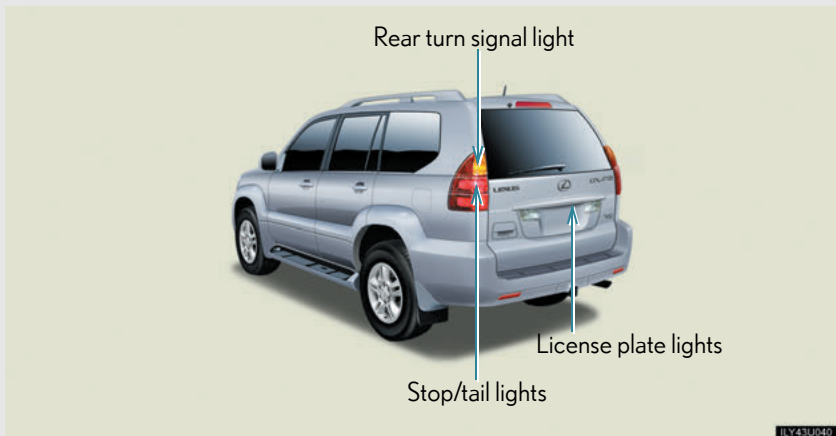

## Replacing light bulbs

### ■ Headlight low and high beam

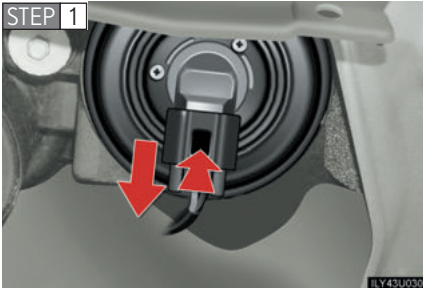

Unplug the connector while pushing the lock release.

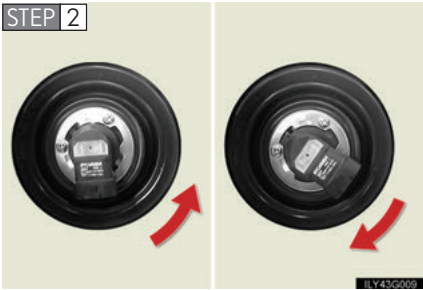

Turn the bulb base counterclockwise to remove it.

### ■ Rear turn signal, stop/tail lights



Open the back door and remove the screws.

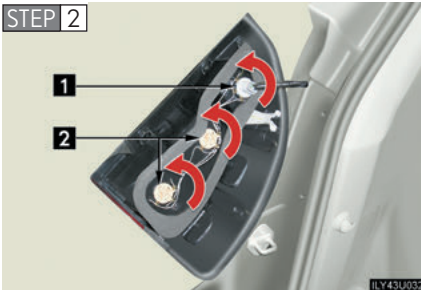

Turn the bulb base counterclockwise.

- 1** Turn signal light
- 2** Stop/tail lights

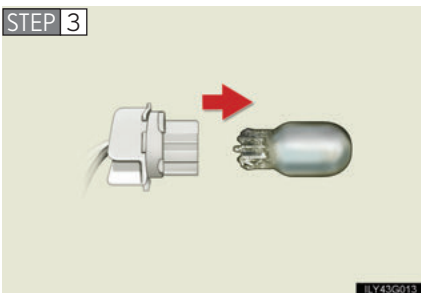

Remove the light bulb.

**License plate light**

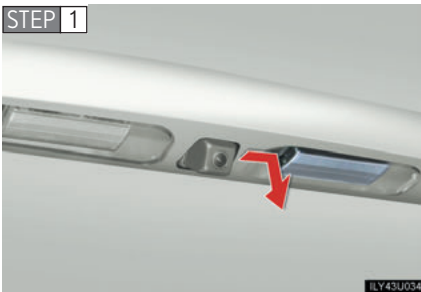

Remove while pressing from the side.

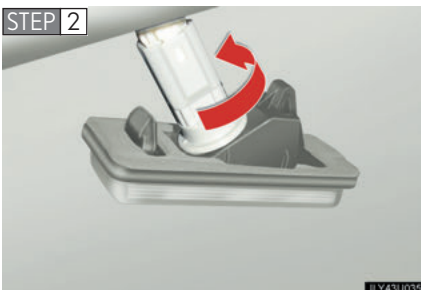

Turn the bulb base counterclockwise.

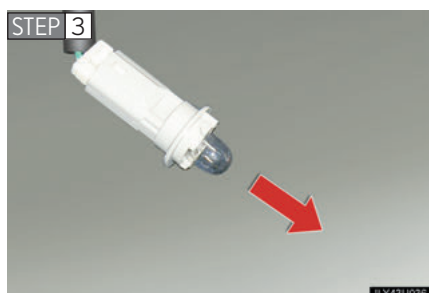

Remove the light bulbs.

### ■ Bulbs other than the above

If any of the bulbs listed below has burnt out, have your Lexus dealer replace it.

- Fog lights
- Parking lights
- Front turn signal lights
- Front side marker lights
- High mounted stoplight
- Back-up lights

---

### ■ Condensation build-up on the inside of the lens

Contact your Lexus dealer for more information in the following situations. Temporary condensation build-up on the inside of the headlight lens does not indicate a malfunction.

- Large drops of water are built up on the inside of the lens.
- Water has built up inside the headlight.

### ■ LED light bulbs

The high mounted stoplights consist of a number of LEDs. If any LEDs burn out, take your vehicle to your Lexus dealer to have the light replaced.

If two or more LEDs in a stoplight burn out, your vehicle may not conform to local laws (SAE).

 **CAUTION****■ Replacing light bulbs**

- Turn off the headlights. Do not attempt to replace the bulb immediately after turning off the headlights.  
The bulbs become very hot and may cause burns.
- Do not touch the glass portion of the light bulb with bare hands. Hold the bulb by the plastic or metal portion.  
If the bulb is scratched or dropped it may blow out or crack.
- Fully install light bulbs and any parts used to secure them. Failing to do so may result in heat damage, fire, or water entering the headlight unit. This may damage the headlights or cause condensation to build up on the lens.
- Do not attempt to repair or disassemble light bulbs, connectors, electric circuits or component parts.  
Doing so may result in serious injury due to electric shock.

**■ To prevent damage or fire**

Make sure bulbs are fully seated and locked.





<b>5-1. Essential information.....</b>	<b>338</b>
If your vehicle needs to be towed .....	338
If you think something is wrong .....	343
Fuel pump shut off system .....	344
Event data recorder .....	345
<b>5-2. Steps to take in an     emergency.....</b>	<b>347</b>
If a warning light turns on or a warning buzzer sounds.....	347
If you have a flat tire.....	356
If the engine will not start.....	367
If the shift lever cannot be shifted from P.....	368
If you lose your keys .....	369
If the vehicle battery is discharged .....	370
If your vehicle overheats .....	373
If the vehicle becomes stuck .....	375

## 5-1. Essential information

### If your vehicle needs to be towed

If towing is necessary, we recommend having your vehicle towed by your Lexus dealer or a commercial towing service, using a lift-type truck or a flat bed truck.

Use a safety chain system for all towing, and abide by all state/provincial and local laws.

The wheels and axle on the ground must be in good condition.

If they are damaged, use a towing dolly or flat bed truck.

#### Before towing

The following may indicate a problem with your transmission. Contact your Lexus dealer before towing.

- The engine is running, but the vehicle will not move.
- The vehicle makes an abnormal sound.

#### Emergency towing

If a tow truck is not available, in an emergency your vehicle may be temporarily towed using a cable or chain secured to the emergency towing eyelet. This should only be attempted on hard, surfaced roads for short distances at low speeds.

A driver must be in the vehicle to steer and operate the brakes. The vehicle's wheels, drive train, axles, steering and brakes must be in good condition.

## ► Towing eyelets



### ■ Emergency towing procedure

**STEP 1** Release the parking brake.

**STEP 2** Put the shift lever in "N".

**STEP 3** The ignition switch must be in the "ACC" position (engine off) or the "ON" position (engine on).

### ⚠ CAUTION

#### ■ Caution while towing

- Use extreme caution when towing the vehicle. Avoid sudden starts or erratic driving maneuvers which place excessive stress on the emergency towing eyelet and the cable or chain.
- If the engine is not running, the power assist for the brakes and steering will not function, making steering and braking more difficult.
- Put the vehicle height in the "N" (normal) mode and push the height control "OFF" switch to turn off rear height control air suspension. Otherwise the automatic leveling function may adjust the vehicle height unexpectedly, resulting in an accident.

### ⚠ NOTICE

#### ■ To prevent causing serious damage to the transmission

Never tow this vehicle from the rear with four wheels on the ground.

### Towing with a sling-type truck



#### NOTICE

**■ To prevent body damage**

Do not tow with a sling type truck, either from the front or rear.

### Towing with a wheel lift-type truck

► From front

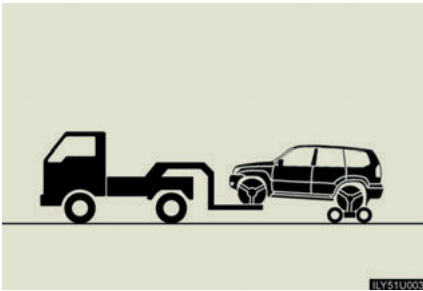

Use a towing dolly under the rear wheels.

#### NOTICE

**■ To prevent causing serious damage to the transmission**

Never tow this vehicle from the front with the rear wheels on the ground.

## ► From rear

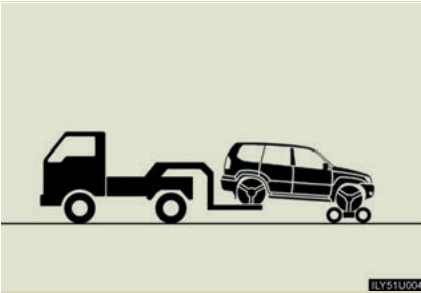

Use a towing dolly under the front wheels.

 NOTICE

## ■ To prevent damaging the vehicle

- Do not tow the vehicle with the ignition switch in the “LOCK” position. The steering lock mechanism is not strong enough to hold the front wheel straight.
- When raising the vehicle, ensure adequate ground clearance for towing at the opposite end of the raised vehicle. Without adequate clearance, the vehicle could be damaged while being towed.

## Using a flat bed truck

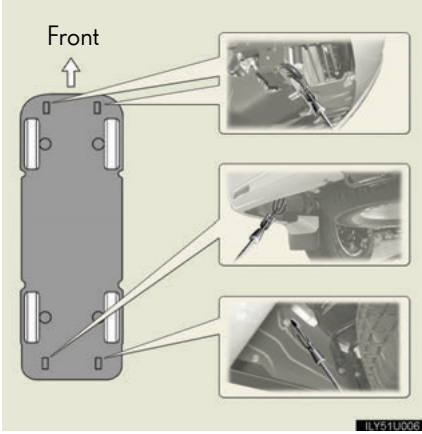

If your Lexus is transported by flat bed truck, it should be tied down at the locations shown in the illustration.

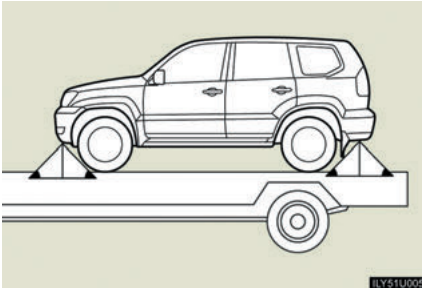

If you use chains or cables to tie down your vehicle, the angles shaded in black must be  $45^\circ$ .

Do not overly tighten the tie downs or the vehicle may be damaged.

# If you think something is wrong

If you notice any of the following symptoms, your vehicle probably needs adjustment or repair. Contact your Lexus dealer as soon as possible.

### ■ Visible symptoms

- Fluid leaks under the vehicle  
(Water dripping from the air conditioning after use is normal.)
- Flat-looking tires or uneven tire wear
- Engine coolant temperature gauge needle continually points higher than normal

### ■ Audible symptoms

- Changes in exhaust sound
- Excessive tire squeal when cornering
- Strange noises related to the suspension system
- Pinging or other noises related to the engine

### ■ Operational symptoms

- Engine missing, stumbling or running rough
- Appreciable loss of power
- Vehicle pulls heavily to one side when braking
- Vehicle pulls heavily to one side when driving on a level road
- Loss of brake effectiveness, spongy feeling, pedal almost touches the floor

## 5-1. Essential information

# Fuel pump shut off system

To minimize the risk of fuel leakage when the engine stalls or an airbag inflates upon collision, the fuel pump shut off system stops supplying fuel to the engine.

■ Follow the procedure below to restart the engine after the system is activated.

**STEP 1** Turn the ignition switch to the “ACC” or “LOCK” position.

**STEP 2** Restart the engine.

### NOTICE

■ **Before starting the engine**

Inspect the ground under the vehicle.

If you find that fuel has leaked on to the ground, the fuel system has been damaged and is in need of repair. Do not restart the engine.



## 5-1. Essential information

# Event data recorder

Your vehicle has computers that monitor and control certain aspects of your vehicle. These computers assist in driving and maintaining optimal vehicle performance.

Besides storing data useful for troubleshooting, there is a system to record data in a crash or a near car crash event. This is called an Event Data Recorder (EDR).

### In a crash or a near car crash event

The EDR may record some or all of the following information.

- Engine speed
- Whether the brake pedal was applied or not
- Vehicle speed
- To what extent the accelerator pedal was depressed
- Position of the transmission shift lever
- Whether the driver and front passenger wore seat belts or not
- Driver's seat position
- Front passenger's occupant classification
- SRS airbag deployment data
- SRS airbag system diagnostic data

Your Lexus' Electronic Control Unit (ECU) may contain another EDR. There are a variety of driving situations which include activating the vehicle stability control (VSC) under which the VSC EDR will record certain information. The VSC EDR may record some or all of the following information:

- Behavior of the vehicle
- Steering wheel angle

- Vehicle speed
- To what extent the accelerator pedal was depressed
- To what extent the brake pedal was applied
- To what extent the ECU controlled the condition of the 4 wheels
- Vehicle stability control system diagnostic data

The information above is intended to be used for the purpose of improving vehicle safety performance. Unlike general data recorders, the EDR does not record sound data such as conversation between passengers.

### Disclosure of the data

Lexus will not disclose the data recorded in an EDR to a third party except when:

- An agreement from the vehicle's owner (or the leasing company for a leased vehicle) is obtained
- Officially requested by the police or other authorities
- Used as a defense for Lexus in a law suit
- Ordered by a court

However, if necessary Lexus will:

- Use the data for research on Lexus vehicle safety performance
- Disclose the data to a third party for research purposes without disclosing details of the vehicle owner, and only when it is deemed necessary
- Disclose summarized data cleared of vehicle identification information to a non-Lexus organization for research purposes



## 5-2. Steps to take in an emergency

### If a warning light turns on or a warning buzzer sounds...

Calmly perform the following actions if any of the warning lights turn on or flash. If a light turns on or flashes, but then turns off, this does not necessarily indicate a malfunction in the system.



**Stop the vehicle immediately. Continuing to drive the vehicle may be dangerous.**

The following warning indicates a possible problem in the brake system. Immediately stop the vehicle in a safe place and contact your Lexus dealer.

Warning light	Warning light/Details
 (U.S.A.)	<b>Brake system warning light</b> <ul style="list-style-type: none"><li>• Low brake fluid</li><li>• Malfunction in the brake system</li></ul> This light also comes on when the parking brake is not released. If the light turns off after the parking brake is fully released, the system is operating normally.
 (Canada)	



**Stop the vehicle immediately.**







The following warning indicates the possibility of damage to the vehicle that may lead to an accident. Immediately stop the vehicle in a safe place and contact your Lexus dealer.

Warning light	Warning light/Details
	<p><b>Charging system warning light</b> Indicates a malfunction in the vehicle's charging system while the engine is running.</p>
	<p><b>Low engine oil pressure warning light</b> Indicates an abnormal level of engine oil pressure. This warning light may turn on if the level of engine oil declines. The light should turn off after checking the oil and adding oil if necessary.</p>

**Have the vehicle inspected by your Lexus dealer immediately.**





Failing to investigate the cause of the following warnings may lead to the system operating abnormally and possibly cause an accident. Have the vehicle inspected by your Lexus dealer immediately.



Warning light	Warning light/Details
 (U.S.A.)  (Canada)	<p><b>Malfunction indicator lamp</b> Malfunction in:</p> <ul style="list-style-type: none"> <li>• The electronic engine control system;</li> <li>• The electronic throttle control system; or</li> <li>• The electronic automatic transmission control system.</li> </ul>
	<p><b>SRS warning light</b> Malfunction in:</p> <ul style="list-style-type: none"> <li>• The SRS airbag system;</li> <li>• The front passenger occupant classification system; or</li> <li>• The seat belt pretensioner system.</li> </ul>

Warning light	Warning light/Details
 (U.S.A.)  (Canada)	<b>ABS warning light</b> Malfunction in: <ul style="list-style-type: none"> <li>• The ABS; or</li> <li>• The brake assist system.</li> </ul>
	<b>VSC/TRAC warning light</b> Malfunction in: <ul style="list-style-type: none"> <li>• The VSC;</li> <li>• The active traction control system;</li> <li>• The downhill assist control system; or</li> <li>• The hill-start assist control system.</li> </ul>
	<b>Automatic transmission fluid temperature warning light</b> Indicates that the automatic transmission fluid temperature is too high.
	<b>Unengaged “Park” warning light</b> Malfunction in the transmission “Park” mechanism.
 (if equipped)	<b>Kinetic dynamic suspension system warning light</b> Malfunction in the kinetic dynamic suspension system.

**Have the malfunction repaired immediately.**

After taking the specified steps to correct the suspected problem, check that the warning light turns off.

Warning light	Warning light/Details	Correction procedure
	<p><b>Open door warning light</b> A door or a back door is not fully closed.</p>	<p>Check that all doors and the back door are closed.</p>
	<p><b>Low fuel level warning light</b> Remaining fuel (Approximately 2.9 gal. [11 L, 2.4 Imp.gal.] or less)</p>	<p>Refuel the vehicle.</p>
	<p><b>Low washer fluid warning light</b> Low level of washer fluid.</p>	<p>Fill the tank.</p>
	<p><b>Engine oil replacement reminder light</b></p>	
	<p>Illuminates for about 3 seconds and then flashes for about 12 seconds: The engine oil is scheduled to be changed.</p>	<p>Check the engine oil, and change if necessary.</p>
	<p>Comes on and remains on: The engine oil should be changed.</p>	<p>Check and change the engine oil.</p>

Warning light	Warning light/Details	Correction procedure
	<b>Driver's seat belt reminder light (warning buzzer)*</b> Warns the driver to fasten his/her seat belt.	Fasten the seat belt.
	<b>Front passenger's seat belt reminder light</b> Warns the front passenger to fasten his/her seat belt.	Fasten the seat belt.
	<b>Tire pressure warning light</b>	
	When the light comes on: Low tire inflation pressure.	Adjust the tire inflation pressure.
	When the light stays on after blinking for 1 minute: Malfunction in the tire pressure warning system.	Have the system checked by your Lexus dealer.

\*: Driver's seat belt reminder buzzer:

The driver's seat belts reminder sounds to alert the driver that his or her seat belt is not fastened. Once the ignition key is turned to the "ON" or "START" position, the reminder light flashes and a buzzer sounds if the driver's seat belt is not fastened. Unless the driver fastens the belt, the light continues flashing, however the buzzer stops after about 4 to 8 seconds.

### ■ If the malfunction indicator lamp comes on while driving

First check the following:

- Is your vehicle low on gas?  
If it is, refuel the vehicle immediately.
- Is the fuel tank cap loose?  
If it is, tighten it securely.

The light will go off after taking several driving trips.

If the light does not go off even after several trips, contact your Lexus dealer as soon as possible.

### ■ Front passenger detection sensor and passenger seat belt reminder

- If luggage is placed on the front passenger seat, the front passenger detection sensor may cause the warning light to flash, even if a passenger is not sitting in the seat.
- If a cushion is placed on the seat, the sensor may not detect a passenger, and the warning light may not operate properly.

### ■ SRS warning light

This warning light system monitors the following:

- The airbag sensor assembly
- Front airbag sensors
- The curtain shield airbag sensors
- The side and curtain shield airbag sensors
- The occupant detection system (ECU and sensors)
- "AIRBAG ON" and "AIRBAG OFF" indicator lights
- The seat belt buckle switches
- The driver's seat position sensor
- The driver's seat belt buckle switch
- Front passenger's seat belt buckle switch
- The inflators
- The warning light
- The interconnecting wiring and power sources



**■ When the tire pressure warning light comes on**

Check the tire inflation pressure and adjust to the appropriate level.

**■ The tire pressure warning light may turn on due to natural causes**

The tire pressure warning light may turn on due to natural causes such as natural air leaks or tire inflation pressure changes caused by temperature. In this case, adjusting the tire inflation pressure will turn off the warning light.

**■ When a tire is replaced with a spare tire**

The spare tire is also equipped with the tire pressure warning valve and transmitter. The tire pressure warning light will turn on if the tire inflation pressure of the spare tire is low. If a tire goes flat, even though the flat tire is replaced with the spare tire, the warning light does not turn off. Replace the spare tire with the repaired tire and adjust the proper tire inflation pressure. The warning light will turn off after a few minutes.

**■ If the tire pressure warning system is inoperative**

The tire pressure warning system may become inoperative in the following conditions:

(When the condition becomes normal, the system will work properly.)

- If tires not equipped with tire pressure warning valves and transmitters are used.
- If the ID code on the tire pressure warning valves and transmitters is not registered.
- If electronic devices or facilities using similar radio wave frequencies are nearby.
- If a radio set at similar frequencies is in use in the vehicle.
- If a window tint that affects the radio wave signals is installed.
- If the tire pressure warning select switch is set to a different tire setting.
- If there is a lot of snow or ice on the vehicle, in particular around the wheels or wheel housings.
- If non-genuine Lexus wheels are used.
- If tire chains are used.
- If the tire inflation pressure is 73 psi (500 kPa, 5.1 kgf/cm<sup>2</sup> or bar) or higher.
- If the tire is in a location subject to poor radio wave signal reception.

### ■ If the tire pressure warning light comes on after blinking for 1 minute frequently

If the tire pressure warning light comes on after blinking for 1 minute frequently when the ignition switch is turned to the "ON" position, have it checked by your Lexus dealer.

### ■ After changing the engine oil (U.S.A. only)

Make sure to reset the oil maintenance data. (→P. 292)

## CAUTION

### ■ Maintenance of the tires

Each tire, including the spare (if provided), should be checked monthly when cold and inflated to the inflation pressure recommended by the vehicle manufacturer on the vehicle placard or tire inflation pressure label (tire and load information label). (If your vehicle has tires of a different size than the size indicated on the vehicle placard or tire inflation pressure label [tire and load information label], you should determine the proper tire inflation pressure for those tires.)

As an added safety feature, your vehicle has been equipped with a tire pressure monitoring system (TPMS-tire pressure warning system) that illuminates a low tire pressure telltale (tire pressure warning light) when one or more of your tires is significantly under-inflated. Accordingly, when the low tire pressure telltale (tire pressure warning light) illuminates, you should stop and check your tires as soon as possible, and inflate them to the proper pressure. Driving on a significantly under-inflated tire causes the tire to overheat and can lead to tire failure. Under-inflation also reduces fuel efficiency and tire tread life, and may affect the vehicle's handling and stopping ability.

Please note that the TPMS (tire pressure warning system) is not a substitute for proper tire maintenance, and it is the driver's responsibility to maintain correct tire pressure, even if under-inflation has not reached the level to trigger illumination of the TPMS low tire pressure telltale (tire pressure warning light).

 **CAUTION****■ If the tire pressure warning light comes on**

Be sure to observe the following precautions. Failure to do so could cause loss of vehicle control and result in death or serious injury.

- Stop your vehicle in a safe place as soon as possible. Adjust the tire inflation pressure immediately.
- If the tire pressure warning light comes on even after tire inflation pressure adjustment, it is probable that you have a flat tire. Check the tires. If the tire is flat, change to the spare tire and have the flat tire repaired by the nearest Lexus dealer.
- Avoid abrupt maneuvering and braking. If the vehicle tires deteriorate, you could lose control of the steering wheel or the brakes.

**■ If a blowout or sudden air leakage should occur**

The tire pressure warning system may not activate immediately.

 **NOTICE****■ Precaution when installing a different tire**

When a tire of a different specification or maker is installed, the tire pressure warning system may not operate properly.

## 5-2. Steps to take in an emergency If you have a flat tire

Remove the flat tire and replace it with the spare provided.

### ■ Before jacking up the vehicle

- Stop the vehicle on a hard, flat surface.
- Set the parking brake.
- Shift the shift lever to “P”.
- Turn off the rear height control air suspension. (→P. 123)
- Stop the engine.
- Turn on the emergency flashers.

### ■ Location of the spare tire, jack and tools

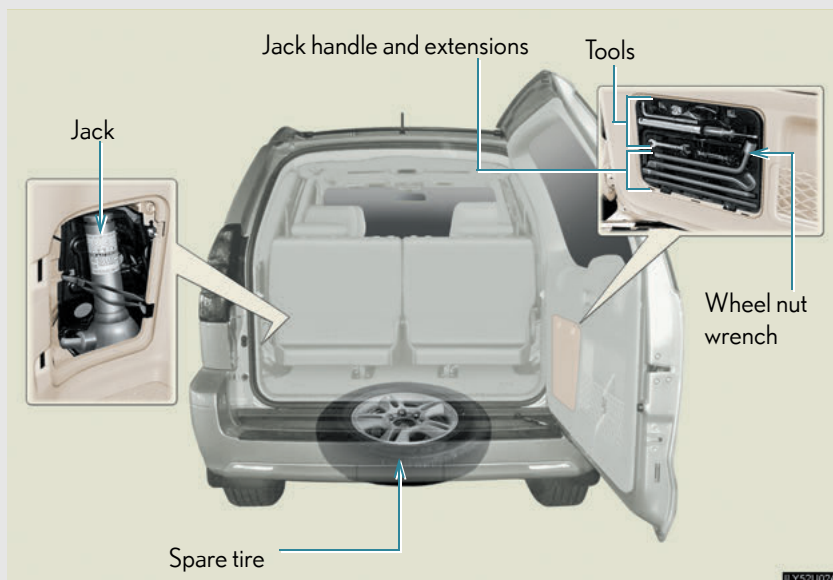

## Taking out the jack and tools

### ▶ Jack

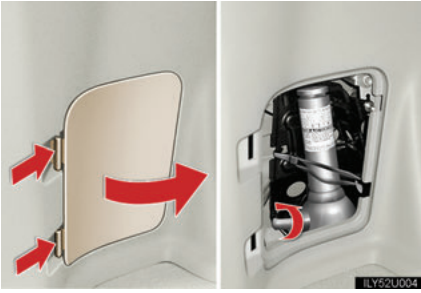

Remove the jack compartment cover and take out the jack.

### ▶ Tools

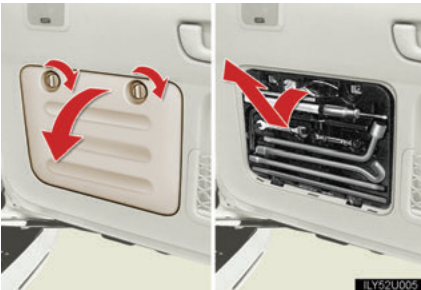

Remove the tool tray compartment cover and take out the tool tray.

### ▶ Jack handle

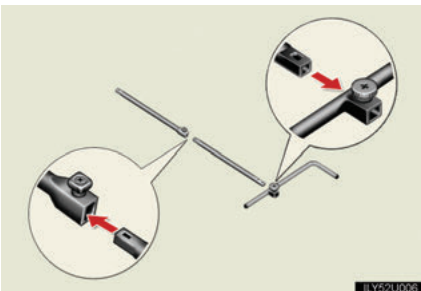

Assemble the jack handle extension as shown. Be sure to tighten each bolt securely.

## Taking out the spare tire

STEP 1

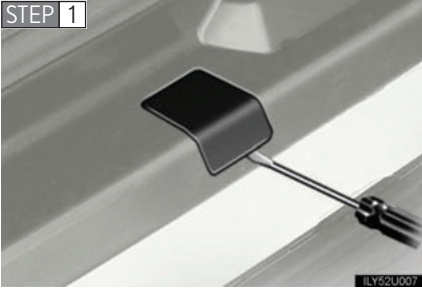

Remove the spare tire carrier lid using a flathead screwdriver.

STEP 2

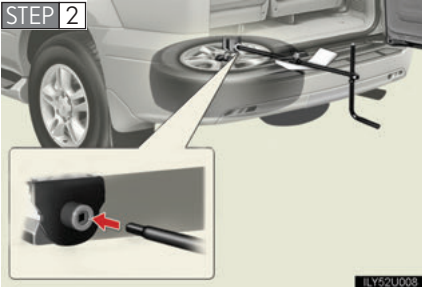

Insert the jack handle extension into the lowering socket.

Place a rag under the jack handle extension to protect the bumper.

STEP 3

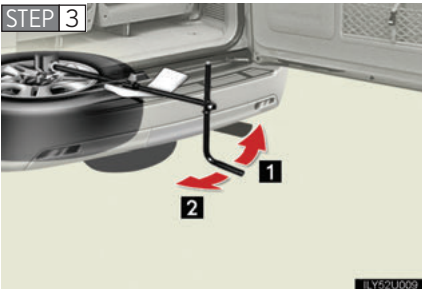

- 1 Lower
- 2 Raise

Lower the spare tire completely to the ground.

Vehicles with kinetic dynamic suspension: If the spare tire becomes caught on the suspension components, raise the tire, pull it towards the rear of the vehicle, and begin lowering it again.

STEP 4



Pull out the spare tire and remove the holding bracket.

## Replacing a flat tire

STEP 1



Chock the tires.

Flat tire		Wheel chock position
Front	Left-hand side	Behind the rear right-hand side tire
	Right-hand side	Behind the rear left-hand side tire
Rear	Left-hand side	In front of the front right-hand side tire
	Right-hand side	In front of the front left-hand side tire

## 5-2. Steps to take in an emergency

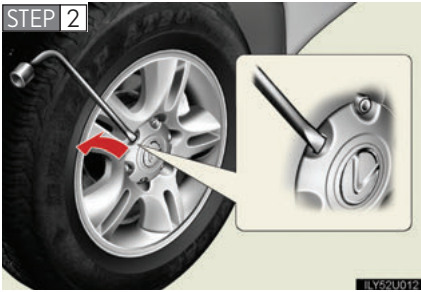

Remove the wheel ornament using the wheel nut wrench as shown.



Slightly loosen the wheel nuts (one turn).

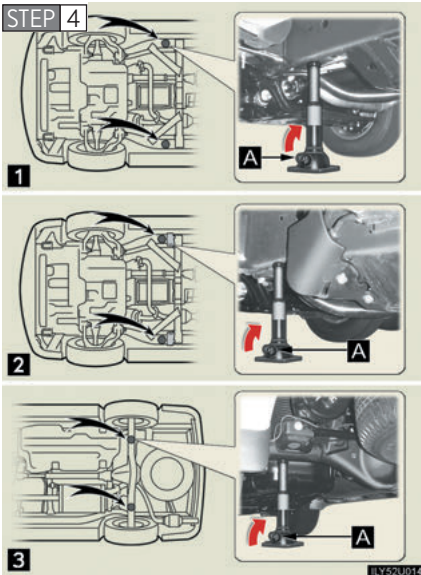

Turn the tire jack portion "A" by hand until the head of the jack is in contact with the appropriate jack point.

- 1 Front (vehicles without kinetic dynamic suspension)
- 2 Front (vehicles with kinetic dynamic suspension)
- 3 Rear



STEP 5

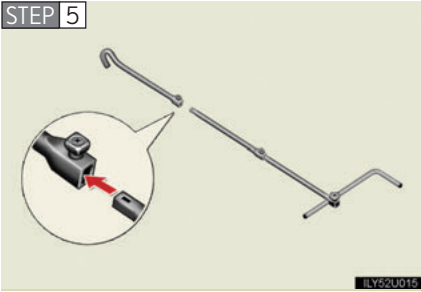

Attach the hooked jack handle end to the jack handle extension as shown.

STEP 6

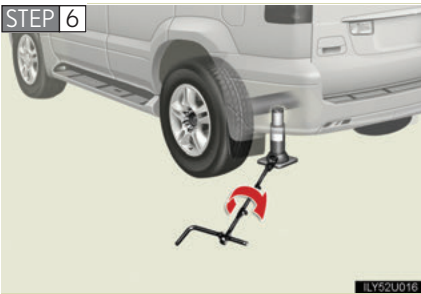

Raise the vehicle until the tire is slightly raised off the ground.

STEP 7



Remove all the wheel nuts and the tire.

When resting the tire on the ground, place the tire so that the wheel design faces up to avoid scratching the wheel surface.

## Installing the spare tire

STEP 1



Remove any dirt or foreign matter from the wheel contact surface.

If foreign matter is on the wheel contact surface, the wheel nuts may loosen while the vehicle is in motion, and the tire may come off the vehicle.

STEP 2

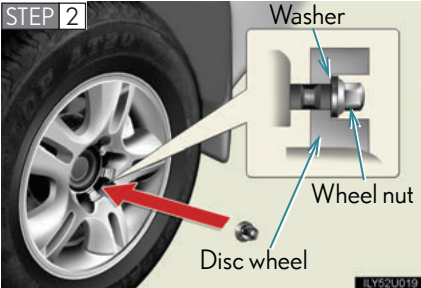

Install the spare tire and loosely tighten each nut by hand to approximately the same amount.

Tighten the wheel nuts until the tapered portion comes into loose contact with the disc wheel sheet.

STEP 3

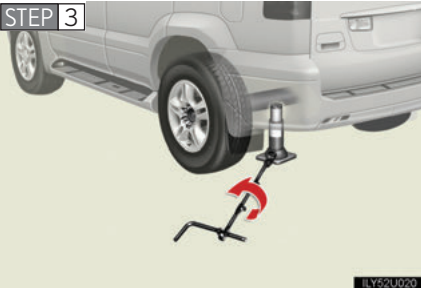

Lower the vehicle.



Firmly tighten each nut two or three times in the order shown in the illustration.

**Tightening torque:**  
83 ft•lbf (112 N•m, 11.5 kgf•m)



Reinstall the wheel ornament.

### Stowing the flat/spare tire, jack and tools



Lay down the tire with the outer side facing up, and install the holding bracket.

**STEP 2** Raise the tire.

Vehicles with kinetic dynamic suspension: Pull the tire towards the rear of the vehicle when raising. After raising, visually check that the tire is not interfering with suspension components.

**STEP 3** Stow the tools and jack securely, and replace all covers.

 **CAUTION**

■ **Using the tire jack**

Improper use of the tire jack may lead to death or injuries due to the vehicle suddenly falling off the jack.

- Do not use the tire jack for any purpose other than replacing tires or installing and removing tire chains.
- Only use the tire jack that comes with this vehicle for replacing a flat tire. Do not use it on other vehicles, and do not use other tire jacks for replacing tires on this vehicle.
- Always check that the tire jack is securely set to the jack point.
- Be sure to turn off the rear height control air suspension and stop the engine.
- Do not raise the vehicle while someone is in it.
- When raising the vehicle, do not put an object on or under the jack.
- Do not raise the vehicle to a height greater than that required to replace the tire.
- Use a jack stand if it is necessary to get under the vehicle.
- Do not put any part of your body under the vehicle supported by a jack.
- Do not start or run the engine while your vehicle is supported by the jack.

Take particular care when lowering the vehicle to ensure that no one working on or near the vehicle may be injured.

■ **Using the jack handle**

Tighten all the jack handle bolts securely using a Phillips-head screwdriver, to prevent the extension parts from coming apart unexpectedly.

 **CAUTION****■ Replacing a flat tire**

Observe the following precautions to reduce the risk of injury.

- Lower the spare tire completely to the ground before removing it from under the vehicle.
- Do not try to remove the wheel ornament by hand. Take due care in handling the ornament to avoid unexpected personal injury.
- Never use oil or grease on the wheel bolts or wheel nuts.  
The oil or grease can cause the wheel nuts to loosen, causing a serious accident.  
Remove any oil or grease on the wheel bolts or wheel nuts.
- Have the wheel nuts tightened with a torque wrench to 83 ft•lbf (112 N•m, 11.5 kgf•m) as soon as possible after changing wheels.  
Failure to follow these precautions could cause the nuts to loosen and the wheels may fall off, which could lead to an accident causing death or serious injury.
- Do not attach a heavily damaged wheel ornament, as it may fly off the wheel while the vehicle is moving.

### NOTICE

#### ■ **Do not drive the vehicle with a flat tire**

Do not continue driving with a flat tire.

Driving even a short distance with a flat tire can damage the tire and the wheel beyond repair.

#### ■ **When stowing the flat tire**

- Ensure that there is no object caught between the tire and the vehicle underbody.
- Vehicles with kinetic dynamic suspension: To avoid damaging the suspension system, make sure that the spare tire does not interfere with the suspension components when stowed.

#### ■ **When replacing the tires**

- When removing or fitting the wheels, tires or the tire pressure warning valve and transmitter, contact your Lexus dealer as the tire pressure warning valve and transmitter may be damaged if not handled correctly.
- Replace the grommets for the tire pressure warning valves and transmitters as well.

#### ■ **To avoid damaging the tire pressure warning valves and transmitters**

Do not use liquid sealants on flat tires.

## 5-2. Steps to take in an emergency If the engine will not start

If the engine will not start even though correct starting procedures are being followed (→P. 95), consider each of the following points.

### ■ The engine will not start even when the starter motor operates normally

One of the following may be the cause of the problem.

- There may not be sufficient fuel in the vehicle's tank.

Add fuel to the vehicle.

- The engine may be flooded.

Try to restart the engine once more following correct starting procedures. (→P. 95)

- There may be a malfunction in the engine immobilizer system.

(→P. 49)

### ■ The starter motor turns over slowly, interior lights and headlights are dim, or the horn does not sound or sounds at a low volume

One of the following may be the cause of the problem.

- The battery may be discharged. (→P. 370)

- The battery terminal connections may be loose or corroded.

### ■ The starter motor does not turn over, interior lights and headlights do not turn on, or the horn does not sound

One of the following may be the cause of the problem.

- One or both of the battery terminals may be disconnected.

- The battery may be discharged. (→P. 370)

Contact your Lexus dealer if the problem cannot be repaired, or if repair procedures are unknown.

## 5-2. Steps to take in an emergency

### If the shift lever cannot be shifted from P

If the shift lever cannot be shifted with your foot on the brake, there may be a problem with the shift lock system (a system to prevent accidental operation of the shift lever). Have the vehicle inspected by your Lexus dealer immediately.

The following steps may be used as an emergency measure to ensure that the shift lever can be shifted.

**STEP 1** Set the parking brake.

**STEP 2** Turn the ignition switch to the "ON" position.

**STEP 3** Depress the brake pedal.

**STEP 4**



Pry the cover up with a flathead screwdriver or equivalent.

**STEP 5**



Press the shift lock override button.

The shift lever can be shifted while the button is pressed.



## 5-2. Steps to take in an emergency

### If you lose your keys

New genuine Lexus keys can be made and programmed to your vehicle by your Lexus dealer, using one of the other keys or the key number stamped on your key number plate.

## 5-2. Steps to take in an emergency

### If the vehicle battery is discharged

The following procedures may be used to start the engine if the vehicle's battery is discharged.

You can call your Lexus dealer, Roadside Assistance or Lexus Customer Service.

If you have a set of jumper (or booster) cables and a second vehicle with a 12 volt battery, you can jump start your Lexus by following the steps below.

**STEP 1** Open the hood.

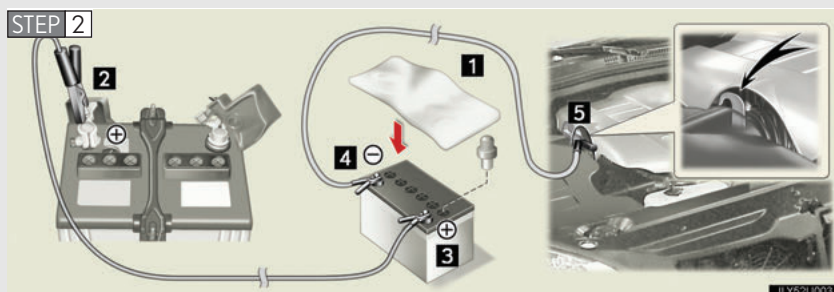

Connecting the jumper cables.

- 1** If required, remove all vent plugs from the booster battery. Lay a cloth over the open vents on the booster battery. (This helps reduce the chance of explosion, personal injuries and burns.)
- 2** Positive (+) battery terminal on your vehicle.
- 3** Positive (+) battery terminal on the second vehicle.
- 4** Negative (-) battery terminal on the second vehicle.
- 5** Negative (-) battery terminal on your vehicle.

**STEP 3** Start the engine of the second vehicle. Increase the engine speed slightly and maintain at that level for approximately 5 minutes to recharge the 12 volt battery of your vehicle.

**STEP 4** Maintain the engine speed of the second vehicle and start your vehicle's engine.

**STEP 5** Once your vehicle's engine has started, remove the jumper cables in the exact reverse order in which they were connected.

Once the engine starts, have the vehicle checked at your Lexus dealer as soon as possible.

■ **To prevent battery discharge**

- Turn off the headlights and the audio system while the engine is off.
- Turn off any unnecessary electrical components when the vehicle is running at a low speed for an extended period, such as in heavy traffic, etc.

■ **When the battery is removed or discharged**

The power windows and moon roof must be initialized.

 **CAUTION**

■ **Avoiding battery fires or explosions**

Observe the following precautions to prevent accidentally igniting the flammable gas that may be emitted from the battery.

- Make sure the jumper cable is connected to the correct terminal and that it is not unintentionally in contact with any part other than the intended terminal.
- Do not allow the jumper cables to come into contact with the “+” and “-” terminals.
- Do not allow open flame or use matches, cigarette lighters or smoke near the battery.

 **CAUTION**

■ **Battery precautions**

The battery contains poisonous and corrosive acidic electrolyte, while related parts contain lead and lead compounds. Observe the following precautions when handling the battery:

- When working with the battery, always wear safety glasses and take care not to allow any battery fluids (acid) to come into contact with skin, clothing or the vehicle body.
- Do not lean over the battery.
- If the battery fluid comes into contact with the skin or eyes, immediately wash the affected area with water and seek medical attention.  
Place a wet sponge or cloth over the affected area until medical attention can be received.
- Always wash your hands after handling the battery support, terminals, and other battery-related parts.
- Do not allow children near the battery.

 **NOTICE**

■ **To avoid damaging the vehicle**

Do not pull or push-start the vehicle, as the three-way catalytic converter may overheat and become a fire hazard.

■ **When handling jumper cables**

Be careful that the jumper cables do not become tangled in the cooling fan or any of the belts when connecting or disconnecting them.

## 5-2. Steps to take in an emergency If your vehicle overheats

### If the engine overheats:

**STEP 1** Stop the vehicle in a safe place and turn off the automatic air conditioning system.

**STEP 2** Check to see if steam is coming out from under the hood.

If you see steam:

Turn off the engine and carefully lift the hood.

If you do not see steam:

Leave the engine running and carefully lift the hood.

**STEP 3** Check to see if the cooling fan is operating.

If the fan is operating:

Wait until the engine coolant temperature gauge begins to fall and then stop the engine.

If the fan is not operating:

Stop the engine immediately and call your local Lexus dealer.

**STEP 4**

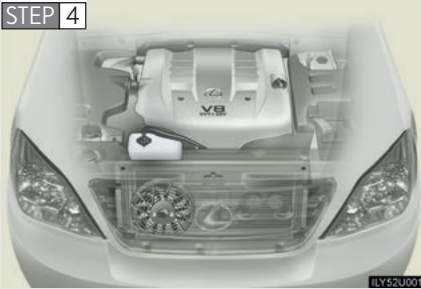

After the engine has cooled down sufficiently, check the coolant level and inspect the radiator for any leaks.

STEP 5



Add coolant if required.

Water can be used as an emergency measure if coolant is unavailable. (→P. 382)

Have the vehicle checked at your nearest Lexus dealer as soon as possible.

### ■ Overheating

In the following situations, your vehicle may be overheating.

- The engine coolant temperature gauge enters the red zone or a loss of power is experienced.
- Steam is coming from under the hood.

### ⚠ CAUTION

#### ■ To prevent an accident or injury when inspecting under the hood of your vehicle

- Keep hands and clothing away from the fan and engine drive belt while the engine is running.
- Do not loosen the radiator cap while the engine and radiator are hot.  
Serious injury, such as burns, may result from hot coolant and steam released under pressure.

### ⚠ NOTICE

#### ■ When adding coolant

Wait until the engine has cooled down before adding coolant.

When adding coolant, do so slowly. Adding cold coolant to a hot engine too quickly can cause damage to the engine.

## 5-2. Steps to take in an emergency If the vehicle becomes stuck

Carry out the following procedures if the tires spin or the vehicle becomes stuck in mud, dirt, or snow.

- STEP 1** Stop the engine. Set the parking brake and shift the shift lever to “P”.
- STEP 2** Remove the mud, snow, or sand from around the stuck tire.
- STEP 3** Place wood, large stones or some other material to help provide traction under the tires.
- STEP 4** Restart the engine.
- STEP 5** Lock the center differential to turn off the vehicle stability control system. (→ P. 121)
- STEP 6** Carefully apply the accelerator to free the vehicle.

### CAUTION

#### ■ When attempting to free a stuck vehicle

If you choose to rock the vehicle back and forth to free it, make sure the surrounding area is clear, to avoid striking other vehicles, objects or persons. The vehicle may also lunge forward or lunge back suddenly as it becomes free. Use extreme caution.

#### ■ When shifting the shift lever

Be careful not to shift the shift lever with the accelerator pedal depressed. This may lead to unexpected rapid acceleration of the vehicle that may cause an accident and result in death or serious injury.

### NOTICE

#### ■ To avoid damaging the transmission and other components

- Avoid spinning the wheels and racing the engine.
- If the vehicle remains stuck after trying these procedures, the vehicle may require towing to be freed.





<b>6-1. Specifications .....</b>	<b>378</b>
Maintenance data.....	378
Fuel information.....	387
Tire information.....	390
<b>6-2. Customization.....</b>	<b>398</b>
Customizable features .....	398
<b>6-3. Initialization.....</b>	<b>401</b>
Items to initialize.....	401

## 6-1. Specifications

### Maintenance data

#### Dimensions and weight

Overall length	188.2 in. (4780 mm)	
Overall width	74.0 in. (1880 mm)	
Overall height * <sup>1</sup>	73.0 in. (1855 mm) * <sup>2</sup>	
	74.6 in. (1895 mm) * <sup>3</sup>	
Wheelbase	109.8 in. (2790 mm)	
Tread	Front	62.4 in. (1585 mm)
	Rear	62.4 in. (1585 mm)
Vehicle capacity weight (Occupants + luggage)		
With third seat	1200 lb. (544 kg)	
Without third seat	1000 lb. (454 kg)	
Towing capacity	6500 lb. (2948 kg)	

\*<sup>1</sup>: Unladen vehicle

\*<sup>2</sup>: Without roof luggage carrier

\*<sup>3</sup>: With roof luggage carrier

## Vehicle identification

The vehicle identification number (VIN) is the legal identifier for your vehicle. This is the primary identification number for your Lexus. It is used in registering the ownership of your vehicle.



This number is stamped on the top left of the instrument panel.



This number is also on the Certification Label.

## Engine number

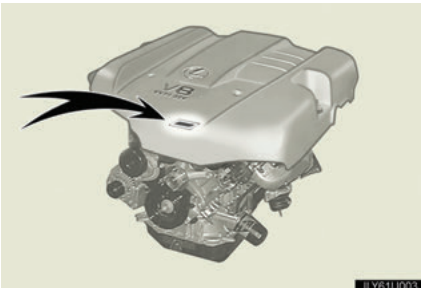

The engine number is stamped on the engine block as shown.

### Engine

Model	2UZ-FE
Type	8-cylinder V type, 4-cycle, gasoline
Bore and stroke	3.70 × 3.31 in. (94.0 × 84.0 mm)
Displacement	284.5 cu.in. (4664 cm <sup>3</sup> )
Drive belt tension	Automatic adjustment

### Fuel

Fuel type	Premium unleaded gasoline only
Octane rating	91 (Research Octane Number 96) or higher
Fuel tank capacity	23 gal. (87 L, 19.1 Imp.gal)

## Lubrication system

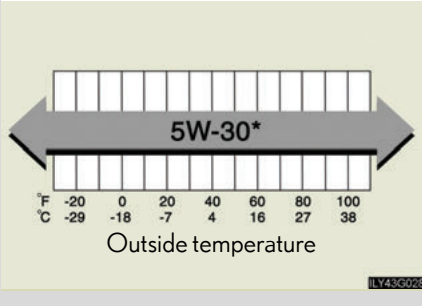
<p>Oil capacity (drain and refill)</p> <p>with filter without filter</p>	<p>6.5 qt. (6.2 L, 5.5 Imp.qt.) 6.0 qt. (5.7 L, 5.0 Imp.qt.)</p>
<p>Oil grade</p>	<p>ILSAC multigrade engine oil</p>
<p>Recommended oil viscosity</p>	<p>Use Lexus approved “Toyota Genuine Motor Oil” or equivalent to satisfy the above grade and viscosity.</p> 

\*:5W-30 is an oil that provides optimal levels of fuel efficiency.

Oil viscosity:

- The 5W portion of the oil viscosity rating indicates the characteristic of the oil which allows cold startability. Oils with a lower value before the W allow for easier starting of the engine in cold weather.
- The 30 in 5W-30 indicates the oil viscosity when the oil is at its operating temperature. An oil with a higher viscosity may be better suited if the vehicle is operated at high speeds, or under extreme load conditions.

### Cooling system

Capacity	13.6 qt. (12.9 L, 11.4 Imp.qt.)
Coolant type	Use either of the following: <ul style="list-style-type: none"> <li>• “Toyota Super Long Life Coolant”</li> <li>• Similar high-quality ethylene glycol-based non-silicate, non-amine, non-nitrite, and non-borate coolant with long-life hybrid organic acid technology</li> </ul> Do not use plain water alone.

### Ignition system

Spark plug	
Make	DENSO NGK
	SK20R11 IFR6A11
Gap	0.043 in. (1.1 mm)

 NOTICE

**■ Iridium-tipped spark plugs**

Use only iridium-tipped spark plugs. Do not adjust the gap when tuning the engine.

## Electrical system

Battery	
Open voltage at 68°F (20°C):	12.6 — 12.8V Fully charged 12.2 — 12.4V Half charged 11.8 — 12.0V Discharged (Voltage is checked 20 minutes after the key is removed with all the lights turned off.)
Charging rates	5A max.

## Differential

Oil capacity	
Front	1.5 qt. (1.4 L, 1.2 Imp.qt.)
Rear	3.3 qt. (3.1 L, 2.7 Imp.qt.)
Oil type and viscosity	Hypoid gear oil API GL-5 Above 0°F (-18°C): SAE 90 or SAE 85W-90 Below 0°F (-18°C): SAE 80W or SAE 80W-90

## Transfer

Oil capacity	1.5 qt. (1.4 L, 1.2 Imp.qt.)
Oil type	Hypoid gear oil API GL-5
Recommended oil viscosity	SAE 75W-90

## Transmission

Fluid capacity Drain and refill	3.2 qt. (3.0 L, 2.6 Imp.qt.)
Fluid type	Toyota Genuine ATF WS

### NOTICE

#### ■ Transmission fluid type

Using transmission fluid other than “Toyota Genuine ATF WS” may cause deterioration in shift quality, locking up of your transmission accompanied by vibration, and ultimately damage the transmission of your vehicle.

## Brakes

Pedal clearance <sup>*1</sup>	2.0 in. (52 mm) Min.
Pedal free play	0.04 — 0.24 in. (1.0 — 6.0 mm)
Brake pad wear limit	0.04 in. (1.0 mm)
Parking brake adjustment <sup>*2</sup>	5 — 7 clicks
Parking brake lining wear limit	0.04 in. (1.0 mm)
Fluid type	SAE J1703 or FMVSS No. 116 DOT 3

<sup>\*1</sup>: Minimum pedal clearance when depressed with a force of 490 N (50 kgf, 110 lbf) while the engine is running.

<sup>\*2</sup>: Parking brake adjustment when depressed with a force of 196 N (20 kgf, 44 lbf).



## Chassis lubrication

Propeller shafts	
Spiders	Lithium base chassis grease, NLGI No.2
Slide yoke	Molybdenum-disulfide lithium base chassis grease, NLGI No.2 or lithium base chassis grease, NLGI No.2

## Steering

Free play	Less than 1.2 in. (30 mm)
Power steering fluid	Automatic transmission fluid DEXRON® II or III

## Tires and wheels

Tire size	P265/65R17 110S
Tire inflation pressure (Recommended cold tire inflation pressure)	Driving under normal conditions 32 psi (220 kPa, 2.2 kgf/cm <sup>2</sup> or bar) Driving at high speeds above 100 mph (160 km/h) (in countries where such speeds are permitted by law) Add 9 psi (60 kPa, 0.6 kgf/cm <sup>2</sup> or bar) to the front tires and rear tires. Never exceed the maximum cold tire inflation pressure indicated on the tire sidewall.
Wheel size	17 × 7 1/2 JJ
Wheel nut torque	83 ft•lbf (112 N•m, 11.5 kgf•m)

## Light bulbs

	Light Bulbs	Bulb No.	W	Type
Exterior	Headlights (low beam)	—	55	A
	Headlights (high beam)	9005	60	B
	Front turn signal lights	4157NAK	27/8	D
	Parking lights	168	5	C
	Fog lights	—	55	E
	Front side marker light	168	5	C
	Stop/tail lights	7443	21/5	C
	Stop/tail and rear side marker lights	7443	21/5	C
	Rear turn signal lights	7440	21	C
	Back-up lights	7440	21	C
	Running board lights	194	3.8	C
	License plate lights	168	5	C
Interior	Vanity lights	—	2	F
	Personal lights	—	8	G
	Interior lights	—	8	F
	Door courtesy lights	—	3.8	G
	Glove box light	—	1.2	C

- A: H11 halogen bulbs  
 B: HB3 halogen bulbs  
 C: Wedge base bulbs (clear)  
 D: Wedge base bulbs (amber)  
 E: H3 halogen bulbs  
 F: Double end bulbs  
 G: Single end bulbs

# Fuel information

Your vehicle must use only unleaded gasoline.

Premium unleaded gasoline with an Octane Rating of 91 (Research Octane Number 96) or higher required for optimum engine performance.

At minimum, the gasoline you use should meet the specifications of ASTM D4814 in the U.S.A. and CGSB3.5-M93 in Canada.

---

### ■ Fuel tank opening for unleaded gasoline

To help prevent incorrect fueling, your Lexus has a fuel tank opening that only accommodates the special nozzle on unleaded fuel pumps.

### ■ If premium gasoline is not available

If this premium fuel is not available, you may use unleaded gasoline with an octane rating as low as 87 (Research Octane Number 91).

### ■ If your engine knocks

- Consult your Lexus dealer.
- You may occasionally notice light knocking for a short time while accelerating or driving uphill. This is normal and there is no need for concern.

### ■ Gasoline quality

In very few cases, driveability problems may be caused by the brand of gasoline you are using. If driveability problems persist, try changing the brand of gasoline. If this does not correct the problem, consult your Lexus dealer.

### ■ Gasoline quality standards

- Automotive manufacturers in the US, Europe and Japan have developed a specification for fuel quality called World-Wide Fuel Charter (WWFC) that is expected to be applied worldwide.
- The WWFC consists of four categories that are based on required emission levels. In the US, category 3 or 4 has been adopted.
- The WWFC improves air quality by lowering emissions in vehicle fleets, and customer satisfaction through better performance.

### ■ Lexus recommends the use of gasoline containing detergent additives

- Lexus recommends the use of gasoline that contains detergent additives to avoid build-up of engine deposits.
- All gasoline sold in the US contains detergent additives to clean and/or keep clean intake systems.

### ■ Lexus recommends the use of cleaner burning gasoline

Cleaner burning gasoline, including reformulated gasoline that contains oxygenates such as ethanol or MTBE (Methyl Tertiary Butyl Ether) is available in many areas.

Lexus recommends the use of cleaner burning gasoline and appropriately blended reformulated gasoline. These types of gasoline provide excellent vehicle performance, reduce vehicle emissions and improve air quality.

### ■ Lexus does not recommend blended gasoline

- Lexus allows the use of oxygenate blended gasoline where the oxygenate content is up to 10% ethanol or 15% MTBE.
- If you use gasohol in your Lexus, be sure that it has an octane rating no lower than 87.
- Lexus DOES NOT recommend the use of gasoline containing methanol.

### ■ Lexus does not recommend gasoline containing MMT

Some gasoline contains octane enhancing additive called MMT (Methylcyclopentadienyl Manganese Tricarbonyl).

Lexus DOES NOT recommend the use of gasoline that contains MMT. If fuel containing MMT is used, your emission control system may be adversely affected.

The malfunction indicator lamp on the instrument cluster may come on. If this happens, contact your Lexus dealer for service.

 NOTICE**■ Notice on gasoline quality**

- Do not use leaded gasoline.

Leaded gasoline can cause damage to your vehicle's three-way catalytic converters causing the emission control system to malfunction.

- Do not use gasohol other than that stated here.

Other gasohol may cause fuel system damage or vehicle performance problems.

- Use of unleaded gasoline with an octane rating lower than 91 may result in engine knocking.

Persistent knocking can lead to engine damage and should be corrected by refueling with higher octane unleaded gasoline.

**■ Fuel-related poor driveability**

If after using a different type of fuel, poor driveability is encountered (poor hot starting, vaporization, engine knocking, etc.), discontinue the use of that type of fuel.

**■ When refueling with gasohol**

Take care not to spill gasohol. It can damage your vehicle's paint.

## 6-1. Specifications

# Tire information

### Typical tire symbols



- 1** Tire size (→P. 392)
- 2** DOT and Tire Identification Number (TIN) (→P. 391)
- 3** Location of tread wear indicators (→P. 302)
- 4** Tire ply composition and materials  
Ply is layers of rubber-coated parallel cords. Cords are the strands which form the plies in a tire.
- 5** Radial tires or bias-ply tires  
A radial tire has RADIAL on the sidewall. A tire not marked RADIAL is a bias-ply tire.
- 6** TUBELESS or TUBE TYPE  
A tubeless tire does not have a tube and air is directly filled in the tire. A tube type tire has a tube inside the tire and the tube maintains the air pressure.
- 7** Load limit at maximum cold tire inflation pressure (→P. 395)
- 8** Maximum cold tire inflation pressure (→P. 395)  
This means the pressure to which a tire may be inflated.
- 9** Uniform tire quality grading  
For details, see “Uniform Tire Quality Grading” that follows.

**10** Summer tire or all season tire

(→P. 305)

An all season tire has “M+S” on the sidewall. A tire not marked “M+S” is a summer tire.

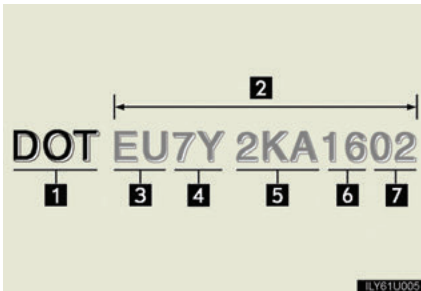
**Typical DOT and tire identification number (TIN)**

- 1** DOT symbol\*
- 2** Tire Identification Number (TIN)
- 3** Tire manufacturer's identification mark
- 4** Tire size code
- 5** Manufacturer's optional tire type code (3 or 4 letters)
- 6** Manufacturing week
- 7** Manufacturing year

\*: The DOT symbol certifies that the tire conforms to applicable Federal Motor Vehicle Safety Standards.

## Tire size

### Typical tire size information

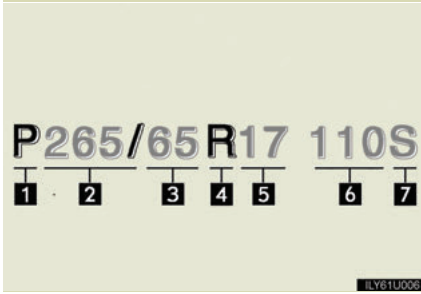

The illustration indicates typical tire size.

- 1 Tire use  
(P = Passenger car,  
T = Temporary use)
- 2 Section width (millimeters)
- 3 Aspect ratio  
(tire height to section width)
- 4 Tire construction code  
(R = Radial, D = Diagonal)
- 5 Wheel diameter (inches)
- 6 Load index (2 or 3 digits)
- 7 Speed symbol  
(alphabet with one letter)

### Tire dimensions

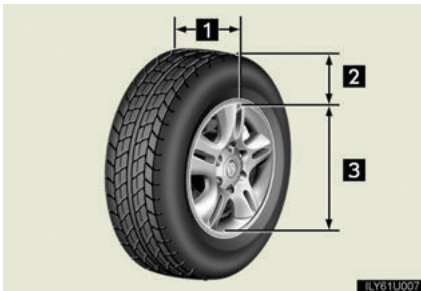

- 1 Section width
- 2 Tire height
- 3 Wheel diameter



## Tire section names

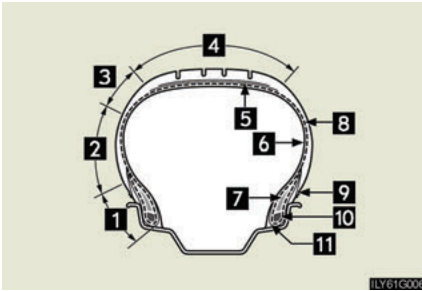

- 1 Bead
- 2 Sidewall
- 3 Shoulder
- 4 Tread
- 5 Belt
- 6 Inner liner
- 7 Reinforcing rubber
- 8 Carcass
- 9 Rim lines
- 10 Bead wires
- 11 Chafer

## Uniform Tire Quality Grading

This information has been prepared in accordance with regulations issued by the National Highway Traffic Safety Administration of the U.S.A. Department of Transportation.

It provides the purchasers and/or prospective purchasers of Lexus vehicles with information on uniform tire quality grading.

Your Lexus dealer will help answer any questions you may have as you read this information.

### ■ DOT quality grades

All passenger vehicle tires must conform to Federal Safety Requirements in addition to these grades. Quality grades can be found where applicable on the tire sidewall between tread shoulder and maximum section width.

For example: Treadwear 200 Traction AA Temperature A

### ■ Treadwear

The treadwear grade is a comparative rating based on the wear rate of the tire when tested under controlled conditions on a specified government test course.

For example, a tire graded 150 would wear one and a half (1 - 1/2) times as well on the government course as a tire graded 100.

The relative performance of tires depends upon the actual conditions of their use, however, and may depart significantly from the norm due to variations in driving habits, service practices and differences in road characteristics and climate.

### ■ Traction AA, A, B, C

The traction grades, from highest to lowest, are AA, A, B and C, and they represent the tire's ability to stop on wet pavement as measured under controlled conditions on specified government test surfaces of asphalt and concrete.

A tire marked C may have poor traction performance.

Warning: The traction grade assigned to this tire is based on braking (straight ahead) traction tests and does not include cornering (turning) traction.

### ■ Temperature A, B, C

The temperature grades are A (the highest), B, and C, representing the tire's resistance to the generation of heat and its ability to dissipate heat when tested under controlled conditions on a specified indoor laboratory test wheel.

Sustained high temperature can cause the material of the tire to degenerate and reduce tire life, and excessive temperature can lead to sudden tire failure.

The grade C corresponds to a level of performance which all passenger car tires must meet under the Federal Motor Vehicle Safety Standard No. 109.

Grades B and A represent higher levels of performance on the laboratory test wheel than the minimum required by law.

Warning: The temperature grades for this tire are established for a tire that is properly inflated and not overloaded.

Excessive speed, underinflation, or excessive loading, either separately or in combination, can cause heat buildup and possible tire failure.

### Glossary of tire terminology

Tire related term	Meaning
Accessory weight	The combined weight (in excess of those standard items which may be replaced) of automatic transmission, power steering, power brakes, power windows, power seats, radio and heater, to the extent that these items are available as factory-installed equipment (whether installed or not)
Cold tire inflation pressure	Tire pressure when the vehicle has been parked for three hours or more, or has not been driven more than 1 mile or 1.5 km under that condition
Curb weight	The weight of a motor vehicle with standard equipment, including the maximum capacity of fuel, oil and coolant, and if so equipped, air conditioning and additional weight optional engine
Maximum inflation pressure	The maximum cold inflated pressure to which a tire may be inflated, shown on the sidewall of the tire
Maximum loaded vehicle weight	The sum of: (a) Curb weight (b) Accessory weight (c) Vehicle capacity weight (d) Production options weight
Normal occupant weight	150 lb. (68 kg) times the number of occupants specified in the second column of Table 1* that follows

Tire related term	Meaning
Production options weight	The combined weight of installed regular production options weighing over 5 lb. (2.3 kg) in excess of the standard items which they replace, not previously considered in curb weight or accessory weight, including heavy duty brakes, ride levelers, roof rack, heavy duty battery, and special trim
Vehicle capacity weight (Total load capacity)	The rated cargo and luggage load plus 150 lb. (68 kg) times the vehicle's designated seating capacity
Intended outboard sidewall	(a) The sidewall that contains a whitewall, bears white lettering, or bears manufacturer, brand, and/or model name molding that is higher or deeper than the same molding on the other sidewall of the tire, or (b) The outward facing sidewall of asymmetrical tire that has a particular side that must always face outward when mounted on a vehicle
Occupant distribution	Distribution of occupants in a vehicle as specified in the third column of Table 1* below
Recommended inflation pressure	Cold tire inflation pressure recommended by a manufacturer.
Rim	A metal support for a tire or a tire and tube assembly upon which the tire beads are seated
Rim diameter (Wheel diameter)	Nominal diameter of the bead seat
Rim size designation	Rim diameter and width
Rim type designation	The industry manufacturer's designation for a rim by style or code
Rim width	Nominal distance between rim flanges

Tire related term	Meaning
Vehicle maximum load on the tire	The load on an individual tire that is determined by distributing to each axle its share of the maximum loaded vehicle weight, and dividing by two
Vehicle normal load on the tire	The load on an individual tire that is determined by distributing to each axle its share of curb weight, accessory weight, and normal occupant weight (distributed in accordance with Table 1* below), and dividing it by two
Weather side	The surface area of the rim not covered by the inflated tire

\*: Table 1 — Occupant loading and distribution for vehicle normal load for various designated seating capacities

Designated seating capacity, Number of occupants	Vehicle normal load, Number of occupants	Occupant distribution in a normally loaded vehicle
2 through 4	2	2 in front
5 through 10	3	2 in front, 1 in second seat

## 6-2. Customization

### Customizable features

Your vehicle includes a variety of electronic features that can be personalized to your preferences. Programming these preferences requires specialized equipment and may be performed by an authorized Lexus dealership.

Some function settings are changed simultaneously with other functions being customized. Contact your Lexus dealer for further details.

Item	Function	Default setting	Customized setting
Wireless remote control (→P. 4)	Wireless remote control	ON	OFF
	Unlocking operation	Driver's door unlocked in 1-step, all doors unlocked in 2-steps	All doors unlocked in 1-step
	Time elapsed before automatic door lock function is activated if door is not opened after being unlocked	30 seconds	60 seconds
	Operation indicator (Emergency flashers)	ON	OFF
	Operation indicator (Buzzer)	ON	OFF
	Panic function	ON	OFF
	Buzzer sounds when pushing the "LOCK" button with any door not closed.	ON	OFF

Item	Function	Default setting	Customized setting
Door lock (→P. 6)	Unlocking using a key	Driver's door unlocked in 1-step, all doors unlocked in 2-steps	All doors unlocked in 1-step
	Speed-detecting automatic door lock function	OFF	ON
	Opening driver's door unlocks all doors	OFF	ON
	Shift the shift lever to "P" unlocks all doors.	ON	OFF
	Shift the shift lever to position other than "P" locks all doors.	ON	OFF
Power windows (→P. 41)	Linked door lock operation	ON	OFF
	Linked door key operation	Open and close	Open only
			Close only
Wireless remote control linked operation	ON	OFF	

Item	Function	Default setting	Customized setting
Moon roof (→P. 43)	Linked door lock operation	ON	OFF
	Linked door key operation	Open and close	Open only
			Close only
	Linked operation of components when door key is used	Slide only	Tilt only
	Wireless remote control linked operation	ON	OFF
Linked operation of components when wireless remote control used	Slide only	Tilt only	
Automatic light control system (→P. 111)	Light sensor sensitivity	Level 3	Levels 1 to 5
	Time elapsed before headlights automatically turn off after doors are closed	30 seconds	0 seconds
			60 seconds
			90 seconds
Daytime running light	ON	OFF*	
Illumination (→P. 225)	Time elapsed before lights turn off	15 seconds	7.5 seconds
			30 seconds
	Operation when the doors are unlocked	ON	OFF
Operation after the ignition switch is turned to the "ACC" position	ON	OFF	

\*: Vehicles sold outside Canada



## 6-3. Initialization Items to initialize

After reconnecting or performing maintenance on the battery, the following items must be initialized for normal system operation.

Item	When to initialize	Reference
Power window	• After reconnecting or changing the battery • After changing a fuse	P. 41
Moon roof		P. 43
Engine oil maintenance data	• After changing engine oil	P. 292



Reporting safety defects for  
U.S. owners..... 410

## Reporting safety defects for U.S. owners

If you believe that your vehicle has a defect which could cause a crash or could cause injury or death, you should immediately inform the National Highway Traffic Safety Administration (NHTSA) in addition to notifying the Lexus Division of Toyota Motor Sales, U.S.A., Inc. (Toll-free: 1-800-25-LEXUS).

If NHTSA receives similar complaints, it may open an investigation, and if it finds that a safety defect exists in a group of vehicles, it may order a recall and remedy campaign. However, NHTSA cannot become involved in individual problems between you, your dealer, or Lexus Division of Toyota Motor Sales, U.S.A., Inc.

To contact NHTSA, you may either call the Auto Safety Hotline toll-free at 1-800-424-9393 (or 366-0123 in Washington, DC area) or write to: NHTSA, U.S. Department of Transportation, Washington, DC 20590. You can also obtain other information about motor vehicle safety from the Hotline.

# Index

Alphabetical index ..... 406

What to do if... ..... 414



Installing CRS with top straps..... 83

**Child safety**

Airbag precautions .....64

Child restraint system .....74

Child-protectors..... 7

How your child should wear  
the seatbelt .....32

Installing child restraints .....77

Moon roof.....43

Power window lock switch ..... 41

Power window precautions.....42

Removed battery  
precautions .....318

Seat belt precautions.....33

Seat heater precautions..... 241

**Cigarette lighter ..... 238**

**Cleaning**

Exterior .....272

Interior .....274

Seat belts .....275

**Clock..... 235**

**Compass ..... 253**

**Condenser..... 295**

**Cooling system**

Engine overheating .....373

**Cruise control**

Cruise control ..... 118

**Cup holders..... 231**

**Curtain shield airbags .....56**

**Customizable features ..... 398**

**D** **Daytime running light system ..... 112**

**Defogger**

Rear window .....169

Side mirror.....169

**Dimension.....378**

**Dinghy towing.....160**

**Display**

Trip information .....108

**Do-it-yourself maintenance .....283**

**Door courtesy lights .....225**

**Door pocket.....232**

**Doors**

Door lock..... 6

Rear door child protector .....7

**Downhill assist control system ..... 130**

**Driver's seat belt reminder light ..... 351**

**Driving**

Correct posture.....54

Procedures .....95

**DVD player ..... 200**

**E** Electronic modulated suspension .. 129

Emergency, in case of

- If a warning light turns on ..... 347
- If the engine will not start..... 367
- If the shift lever cannot be shifted from P ..... 368
- If the vehicle battery is discharged ..... 370
- If you have a flat tire ..... 356
- If you lose your keys..... 369
- If you think something is wrong..... 343
- If your vehicle becomes stuck..... 375
- If your vehicle needs to be towed ..... 338
- If your vehicle overheats ..... 373

**Engine**

- Compartment ..... 287
- Hood..... 286
- How to start the engine..... 95
- If the engine will not start..... 367
- Overheating..... 373

**Engine compartment cover ..... 288**

**Engine coolant temperature gauge..... 103**

**Engine coolant**

- Capacity ..... 382
- Checking ..... 294
- Preparing and checking before winter ..... 146

**Engine immobilizer system..... 49**

**Engine oil**

- Capacity ..... 381
- Checking..... 289
- Preparing and checking before winter..... 146
- Engine oil maintenance data ..... 292**
- Event data recorder ..... 345**

**F** First-aid kit storage belt ..... 246

**Flat key..... 2**

**Floor mats ..... 244**

**Fluid**

- Brake ..... 296
- Power steering ..... 297
- Washer..... 301

**Fog lights**

- Switch..... 113
- Wattage ..... 386

**Foot light ..... 225**

**Front passenger's seat belt reminder light ..... 351**

**Front passenger occupant classification system..... 69**

**Front seats**

- Adjustment ..... 13
- Driving position memory ..... 24

**Front turn signal lights**

- Wattage ..... 386

**Fuel**

- Capacity ..... 380
- Fuel gauge ..... 103
- Gas station information ..... 416
- Information ..... 387
- Refueling..... 46

**Fuel filler door..... 46**

**Fuses ..... 321**



<b>G</b>	Garage door opener.....	248
	Gas station information.....	416
	Gauges.....	103
	Glove box.....	228

<b>H</b>	Head restraints.....	26
	Headlights	
	Replacing light bulbs.....	331
	Switch.....	111
	Wattage.....	386
	Heaters	
	Seat heaters.....	241
	Side mirror.....	169
	Hill-start assist control.....	132
	Hood.....	286
	Hooks	
	Cargo.....	245

<b>I</b>	Ignition switch.....	95
	Illuminated entry system.....	225
	I/M test.....	282
	Indicator lights.....	105
	Initialization	
	Items to initialize.....	401
	Inside rear view mirror.....	36
	Instrument panel light control.....	104
	Interior lights	
	Interior lights.....	225
	Wattage.....	386

<b>J</b>	Jack	
	Replacing the wheel.....	356
	Jack handle.....	356

<b>K</b>	Keys	
	If you lose your keys.....	369
	Key number plate.....	2
	Keys.....	2
	Wireless remote control.....	4
	Kinetic Dynamic Suspension System (KDSS).....	132

<b>L</b>	Lexus Link System.....	257
	Light bulbs	
	Replacing.....	331
	Wattage.....	386
	Lights	
	Fog light switch.....	113
	Headlights switch.....	111
	Interior lights list.....	225
	Replacing light bulbs.....	331
	Turn signal lever.....	101
	Vanity lights.....	234
	Wattage.....	386
	Limited slip differential.....	132
	Luggage cover.....	246

<b>M</b>	<b>Maintenance</b>	
	Do-it-yourself maintenance.....	283
	General maintenance.....	279
	Maintenance data.....	378
	Maintenance requirements.....	277
	<b>Meter</b>	
	Instrument panel light control.....	104
	Meters.....	103
	<b>Mirrors</b>	
	Inside rear view mirror.....	36
	Side mirror heater.....	169
	Side mirrors.....	37
	Vanity mirrors.....	234
	<b>Moon roof.....</b>	<b>43</b>
	<b>MP3 disc.....</b>	<b>188</b>
<b>O</b>	<b>Odometer.....</b>	<b>103</b>
	<b>Off-road precautions</b>	
	Driving.....	137
	Vehicle.....	135
	<b>Oil</b>	
	Engine oil.....	289
	<b>Outside rear view mirrors</b>	
	Adjusting and folding.....	37
	Defogger switch.....	169
	Driving position memory.....	24
	<b>Outside temperature display.....</b>	<b>236</b>
	<b>Overhead console.....</b>	<b>230</b>
	<b>Overheating, Engine.....</b>	<b>373</b>

<b>P</b>	<b>Parking brake.....</b>	<b>102</b>
	<b>Parking lights</b>	
	Replacing light bulbs.....	331
	Switch.....	111
	Wattage.....	386
	<b>Personal lights.....</b>	<b>225</b>
	<b>Power outlet.....</b>	<b>239</b>
	<b>Power windows.....</b>	<b>41</b>
<b>Q</b>	<b>Quarter window.....</b>	<b>245</b>
<b>R</b>	<b>Radiator.....</b>	<b>295</b>
	<b>Radio.....</b>	<b>173</b>
	<b>RDS (Radio Data System).....</b>	<b>175</b>
	<b>Rear console box.....</b>	<b>229</b>
	<b>Rear height control</b>	
	air suspension.....	123
	<b>Rear seat entertainment system</b>	
	A/V input adapter.....	217
	Headphone jacks.....	202
	Remote control.....	205
	<b>Rear seat</b>	
	Folding up the third seat.....	18
	Removing the third seat.....	21
	Tumbling the second seat.....	16
	<b>Rear step bumper.....</b>	<b>11</b>
	<b>Rear turn signal lights</b>	
	Replacing light bulbs.....	331
	Wattage.....	386

Rear window defogger..... 169  
 Rear window wiper and washer .....117  
 Replacing  
     Fuses..... 321  
     Light bulbs ..... 331  
 Reporting safety defects for  
     U.S.A. owners ..... 404  
 Roof luggage carrier .....39

**S**

**Seat belts**  
     Adjusting the seat belt ..... 28  
     Automatic Locking Retractor  
         (ALR)..... 31  
     Child restraint system  
         installation ..... 77  
     Cleaning and maintaining  
         the seat belts.....275  
     Emergency Locking Retractor  
         (ELR)..... 31  
     How to wear your seat belt..... 28  
     How your child should wear  
         the seat belt..... 32  
     Pregnant women,  
         proper seat belt use.....32  
     Reminder light..... 351  
     Seat belt extenders..... 32  
     Seat belt pretensioners..... 31  
**Seat heaters**..... 241  
**Seating capacity** ..... 144

**Seats**

    Child seats/child restraint  
         system installation.....77  
     Cleaning..... 274  
     Driving position memory ..... 24  
     Folding up the third seat..... 18  
     Head restraint..... 26  
     Properly sitting in the seat ..... 54  
     Seat adjustment ..... 13  
     Seat adjustment precautions.....14  
     Seat heaters ..... 241  
     Removing the third seat..... 21  
     Tumbling the second seat ..... 16  
**Security indicator**..... 106  
**Service reminder indicators** ..... 106  
**Shift lever**  
     If the shift lever cannot be  
         shifted from P ..... 368  
**Shift lock system**..... 368  
**Side airbags**..... 56  
**Side marker lights**  
     Switch..... 111  
**Side mirror**  
     Adjusting and folding..... 37  
     Driving position memory ..... 24  
**Spare tire**  
     Inflation pressure..... 385  
**Spark plug**..... 382  
**Specifications** ..... 378  
**Speedometer** ..... 103

Steering wheel	
Adjustment.....	35
Audio switches .....	198
Driving position memory.....	24
<b>Storage feature.....</b>	<b>228</b>
<b>Stuck</b>	
If your vehicle becomes stuck.....	375
<b>Sun visors .....</b>	<b>233</b>
<b>Switch</b>	
"2nd STRT" switch .....	99
Center differential lock switch .....	121
"DAC" switch .....	130
Fog light switch.....	113
Height control off switch.....	123
Light switches.....	111
Power door lock switch.....	6
Power window switch.....	41
"RSCA OFF" switch.....	68
Window lock switch .....	41
Wipers and washer switch.....	114
<b>T</b>	
<b>Tail lights</b>	
Switch .....	111
<b>Theft deterrent system</b>	
Alarm.....	51
<b>Theft prevention labels .....</b>	<b>53</b>
<b>Tire inflation pressure .....</b>	<b>385</b>
<b>Tire information</b>	
Glossary.....	395
Size .....	392
Tire identification number .....	391
Uniform Tire Quality Grading....	393

<b>Tires</b>	
Chains.....	147
Checking.....	302
If you have a flat tire .....	356
Inflation pressure .....	385
Information .....	390
Pressure warning system.....	302
Replacing .....	356
Rotating tires.....	302
Size.....	385
Snow tires.....	148
<b>Tools.....</b>	<b>356</b>
<b>Total load capacity .....</b>	<b>144</b>
<b>Towing</b>	
Dinghy towing .....	160
Emergency towing.....	339
Trailer towing .....	150
<b>Trip information display .....</b>	<b>108</b>
<b>Trip meter .....</b>	<b>103</b>
<b>Turn signal lights</b>	
Replacing light bulbs .....	331
Switch.....	101
Wattage.....	386
<b>V</b>	
<b>Vanity lights</b>	
Vanity lights.....	234
Wattage.....	386
<b>Vanity mirrors .....</b>	<b>234</b>
<b>Vehicle identification number .....</b>	<b>379</b>
<b>Vehicle load limits .....</b>	<b>144</b>
<b>VSC (Vehicle Stability Control) .....</b>	<b>132</b>

**W**

**Warning buzzers**

Seat belt reminder .....351

**Warning lights**

“AIRBAG ON/OFF”

indicators.....106

Anti-lock brake system (ABS) ...349

Brake system.....347

Charging system.....348

Downhill assist control

indicator.....106

Engine oil replacement

reminder light.....350

Height control indicator.....106

Low engine oil pressure.....348

Low fuel level.....350

Low washer fluid.....350

Malfunction indicator lamp .....348

Open door .....350

Seat belt reminder light .....351

SRS airbags .....348

Tire pressure warning light.....351

Unengaged “P” .....349

“VSC TRAC” .....349

**Warning reflector holder.....246**

**Washer**

Checking.....301

Preparing and checking

before winter.....146

Switch.....114

**Washing and waxing .....272**

**Weight**

Cargo capacity .....140

Load limits.....144

Weight.....378

**Wheels ..... 313**

**Window glasses .....41**

**Window lock switch .....41**

**Windows**

Power windows.....41

Rear window defogger.....169

Washer .....114

**Windshield wipers.....114**

**Winter driving tips..... 146**

**Wireless remote control**

Locking/Unlocking ..... 4

Replacing the battery.....317

**WMA disc .....188**

## What to do if...

# What to do if...



A tire punctures

P. 356 If you have a flat tire



The engine does not start

P. 49 Engine immobilizer system

P. 367 If the engine will not start

P. 370 If the battery is discharged



The shift lever cannot be moved out

P. 368 If the shift lever cannot be shifted from "P"



The engine coolant temperature gauge enters the red zone

P. 373 If your vehicle overheats



Steam can be seen coming from under the hood



The key is lost

P. 369 If you lose your keys



The battery is discharged

P. 370 If the vehicle has a discharged battery



The doors cannot be locked

P. 6 Doors



The horn begins to sound

P. 51 Alarm



The vehicle is stuck in mud or sand

P. 375 If the vehicle becomes stuck

 The warning light or indicator light comes on

P. 347 If the warning light turns on



■ Warning lights



Brake system warning light

or



P. 347



Malfunction indicator lamp

or



P. 348



ABS warning light

or



P. 349



Driver's seat belt reminder light

P. 351



Front passenger's seat belt reminder light

P. 351



"VSC/TRAC" warning light

P. 349



Tire pressure warning light

P. 351



Low fuel level warning light

P. 350



Kinetic dynamic suspension system warning light

P. 349



SRS warning light

P. 348



Automatic transmission fluid temperature warning light

P. 349



Open door warning light

P. 350



Unengaged "Park" warning light

P. 349



Charging system warning light

P. 348



Low washer fluid warning light

P. 350



Low engine oil pressure warning light

P. 348

## GAS STATION INFORMATION



Auxiliary catch lever

P.286



Fuel filler door

P.46

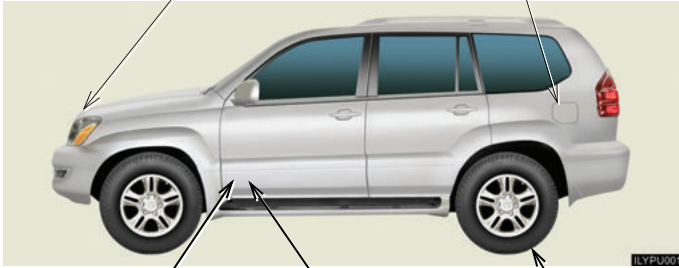

Hood lock release lever

P. 286

Fuel filler door lever

P. 46

Tire inflation pressure

P. 385



Fuel tank capacity	23 gal. (87 L, 19.1 Imp.gal.)	
Fuel type	Premium unleaded gasoline only	P. 47
Cold tire inflation pressure		P. 385
Engine oil capacity (Drain and refill)	With filler Without filler	qt. (L, Imp.qt.) 6.5 (6.2, 5.5) 6.0 (5.7, 5.0)
Engine oil type	"Toyota Genuine Motor Oil" or equivalent Oil grade: ILSAC multigrade engine oil Recommended oil viscosity: SAE 5W-30	P. 381